



PROKLIMA

Guidelines for the safe use of flammable refrigerants in the production of room air-conditioners

A handbook for engineers, technicians, trainers and policy-makers – For a climate-friendly cooling

giz Deutsche Gesellschaft
für Internationale
Zusammenarbeit (GIZ) GmbH



On behalf of



Federal Ministry for the
Environment, Nature Conservation
and Nuclear Safety

of the Federal Republic of Germany

Guidelines for the safe use of flammable refrigerants in the production of room air-conditioners

A handbook for engineers, technicians, trainers and policy-makers – For a climate-friendly cooling

Published by

Deutsche Gesellschaft für Internationale Zusammenarbeit (GIZ) GmbH

Registered Office

Bonn and Eschborn

Programme Proklima

Dag-Hammarskjöld-Weg 1-5

65760 Eschborn, Germany

Internet: www.giz.de/proklima

Programme manager: Bernhard Siegele (bernhard.siegele@giz.de)

On behalf of

Federal Ministry for the Environment, Nature Conservation and Nuclear Safety (BMU)

Programmbüro Internationale Klimaschutzinitiative

Potsdamer Platz 10, 10785 Berlin

E-Mail: programmbuero@programmbuero-klima.de

Phone: +49 (0)30 408 190 - 218

Fax: +49 (0)30 408 190 - 303

Internet: www.international-climate-initiative.com

Author

Proklima, Igor C. Croiset (igor.croiset@proklima.net)

TÜV-Rheinland, Christian Lechtenböhmer

Betaenergia, Paulo Nassano

Editor

Proklima, Rebecca Kirch

Review

Proklima, Dr. Daniel Colbourne

Galileo TP, Luca Pancani

Design

Jeanette Geppert, www.jeanette-geppert.de

Serial number: AC-S01-2012-en-01

Eschborn, February 2012

Proklima is a programme of the Deutsche Gesellschaft für Internationale Zusammenarbeit (GIZ) GmbH. Since 2008 Proklima has been working successfully on behalf of the Federal Ministry for the Environment, Nature Conservation and Nuclear Safety (BMU) under its International Climate Initiative (ICI) to disseminate ozone- and climate-friendly technologies.

Proklima has been providing technical and financial support for developing countries since 1996, commissioned by the German Federal Ministry for Economic Cooperation and Development (BMZ) to implement the provisions of the Montreal Protocol on Substances that Deplete the Ozone Layer.

This publication has been prepared under the project “Conversion of room air-conditioners in China from fluorinated refrigerants to environment-friendly R290 (propane) technology” funded by the German Federal Ministry for the Environment, Nature Conservation and Nuclear Safety (BMU) within the framework of the International Climate Initiative based on a decision of the German Federal Parliament.

Contents

Abbreviations	9
List of figures	10
List of tables	11

1. INTRODUCTION	12
------------------------	-----------

1.1 Definition of flammable	13
1.2 Classification of Flammable Substances according to Directive 67/548/CEE	14
1.3 ATEX standards	15
1.4 Directives applied to work sites with explosion risk	16
1.5 Protection for workers against explosion	19
1.6 Safety measures against explosions	21
1.7 Organisational measures against explosions	23
1.8 Conformity of equipment by applying directive 94/9/CE	29

2. SUBSTANCES IN USE	34
-----------------------------	-----------

2.1 Introduction	34
2.2 Behaviour of liquid- and gaseous products	34
2.3 Fire triangle	37
2.4 Explosion limits	38
2.5 Material Safety Data Sheet	39

3. ATEX AREA	40
---------------------	-----------

3.1 Hazardous areas	40
3.2 Identifying methods for hazardous areas	41

3.3	Classification of zone	47
3.4	Examples of a standard installation classification	48
3.5	Gas detectors	53

4.	ELECTRIC PLANTS: ELECTROSTATIC CHARGES AND ATMOSPHERIC DISCHARGES	56
----	--	-----------

4.1	Introduction	56
4.2	Construction temperature classification	57
4.3	Protection methods allowed by ATEX directive	58
4.4	Materials and constructions in conformity with ATEX	59
4.5	Gas classification sub-groups	61
4.6	Qualification of material for installation in various areas	62
4.7	Atmospheric discharge protection (lightning)	63
4.8	Grounding system – electrostatic discharge	64
4.9	Electrostatic charge	65

5.	STORAGE PLANT AND REFRIGERANT DISTRIBUTION	67
----	---	-----------

5.1	Storage systems	67
5.2	Pressurised tanks	68
5.3	Construction method for storage areas	68
5.3.1	Mobile cylinders under pressure	68
5.3.2	Fixed pressurised tanks	72
5.3.3	Mobile containers at atmospheric pressure	74

6. PRODUCTION AREA AND TEST CHAMBERS	75
6.1 Production line boundary area of application ATEX	77
6.2 Production department - refrigerant charging	78
6.3 Gas detection system-production line	81
6.4 Refrigerant transfer pump – open air placement	82
6.5 Refrigerant transfer pump – closed room placement	83
6.6 Test stations	84
7 SUMMARY IDENTIFICATION OF HAZARDOUS AREAS	88
7.1 Introduction	88
7.2 Quick guide to refrigerant analysis	88
7.3 Quick guide to the identification of hazardous areas	90
7.4 Quick guide to the identification of a substance	91
APPENDICES	92
Appendix 1: Typical refrigerants used	92
Appendix 2: Influence of ventilation on type of Zone	92
Appendix 3: List of standards / references	93

Abbreviations

ATEX	AtmosphereExplosive
BMU	Federal Ministry for the Environment, Nature Conservation and Nuclear Safety
BMZ	Federal Ministry for Economic Cooperation and Development
DME	Dimethylether
EN	EuropeanNorm
ES	Emission Sources
EU	European Union
GIZ	Deutsche Gesellschaft für Internationale Zusammenarbeit
HC	Hydrocarbon
HFC	Hydrofluorocarbon
HV	High ventilation
ICI	International Climate Initiative
LEL	Lower Explosion Limit
LPS	Lightning Protection System
LV	Low ventilation
MSDS	Material Safety Data Sheet
MV	Medium Ventilation
NE	Negligible Extent
PED	Pressure Equipment Directive
SPD	Source Protective Device
UEL	Upper Explosive Limit

List of figures

Figure 1	Symbols for combustive and explosive substances	15
Figure 2	Application of Directives 99/92/CE and 94/9/CE	16
Figure 3	Flow chart for minimum safety prescriptions	19
Figure 4	Symbol to indicate ATEX area	25
Figure 5	Logic for risk assessment	27
Figure 6	Technical organisational protection measures	28
Figure 7	Typical CE marking plate	31
Figure 8	CE Certificate Example	32
Figure 9	The fire triangle	37
Figure 10	Example of Type A opening	42
Figure 11	Example of Type B opening	43
Figure 12	Example of Type C opening	43
Figure 13	Example of Type D opening	43
Figure 14	Low ventilation	45
Figure 15	Medium ventilation	45
Figure 16	High ventilation	46
Figure 17	Procedure schematic for area classification	49
Figure 18	Example – charging gun Galileo TP (picture courtesy of Galileo TP)	52
Figure 19	Example of a plate attached to a gas detector	61
Figure 20	A typical pressurised tank	73
Figure 21	Production department layout	76
Figure 22	EX symbol indicating ATEX area	77
Figure 23	Gas sensor in double and single configuration	62

List of Tables

Table 1	Overview of different risk labels	14
Table 2	An example of a work authorisation form used by Italian firms	26
Table 3	Summary of openings and classification	44
Table 4	Equipment temperature classification	58
Table 5	Summary apparatus category	60
Table 6	Zones with corresponding construction standards	62

1. INTRODUCTION

This document will examine the technical, safety and administrative problems related to the use of flammable gases in the production of air conditioning systems.

The document focuses on production of air conditioners and not on the design or certification of the air conditioner itself. The explanations, descriptions and examples are specifically focused on safety elements required for a proper production. The manufacturer of air conditioners should always be aware of the product quality and on the basis of this knowledge eventually increase the safety system.

The industrial use of flammable gases within the European Union is regulated by two directives approved by each member state.

The directives are¹:

- Directive 99/92/CE² on minimum requirements for improving the health and safety protection of workers potentially at risk from explosive atmospheres
- Directive 94/9/CE³ on equipment and protective systems intended for use in explosive atmospheres.

Basically ATEX is created from these two directives.

Additionally, any gasses under pressure – such as blowing agents or refrigerants – are EU regulated by the directive: Directive 97/23/CE PED regarding pressure equipment.

Always keep in mind that the products in use are flammable and pressurised and no safety system can prevent accidents due to negligence.

This guideline describes in the chapters 1 to 3 the general aspects which have to be taken into account for installing a production line. Chapters 4 to 7 go into detail describing the activities to be taken according to a sample layout. This sample layout helps to give a better understanding of all the aspects.

What has to be considered is that for each installation a safety analysis has to be prepared. This guideline is not a substitution for the latter.

¹ The directives 99/92/CE are generally called "ATEX directives" from "Explosive Atmospheres"

² The denotation of the Directive 99/92/CE is 1999/92/CE

³ The Directive 94/9/CE is Directive 94/9/CEE. Before 1999 the European Union did not exist but the European Economic Union. For the simplicity the two directives are indicated in only one way in this document.

Isobutane (R600a) has been taken as a reference refrigerant in the examples, although it is not used in air conditioners, but in domestic refrigerators. This makes the conversion more understandable. Also the required safety precautions can be demonstrated with a refrigerator production as a comparison.

1.1 Definition of flammable⁴

The term “flammable” means “substance with the capacity to develop an exothermic oxidation reaction”, whilst within the ATEX directives, the definition of explosive atmosphere (which is specifically to what the directives apply) is: a “mixture with air, under atmospheric conditions, of flammable substances in the form of gases, vapours, mists or dusts in which, after ignition has occurred, combustion spreads to the entire unburned mixture”.

The flammable substances are classified by the Directive 67/548/CEE (and the following modifications) and can be identified by the obligatory label placed on the liquid container (see Table 1) and described hereafter.

On the label the risk codes (code R) are quoted according to the symbols shown in the table. For example a symbol F is accompanied by the indication of R11, R15 and R17. Figure 1 shows the symbols that must be shown on labels for explosive and combustive substances.

Thus, each time, a product or substance identified as flammable enters the production cycle, the ATEX directives must be considered. In many cases, the ATEX directives can be met through application of the various European standards that have been harmonised to them.



It does not matter whether a product or substance is “more or less flammable” or only a small percentage of the substance is used or if it is mixed with other substances, in any case, the ATEX must be followed.

⁴ In Atmospheric pressure

1.2 Classification of Flammable Substances according to Directive 67/548/CEE

The following table shows the classification of a substance with the relevant risk labels and the meaning of the risk labels. Every substance delivered should carry a label on which the symbol and the risk labels are shown. This information is indicated on the MSDS (Material Safety Data Sheets).

Table 1: Overview of different risk labels

Classification	Risk Labels	Description	Symbol
Flammable	R10 Flammable	Liquid substance with flash point between 21°C and 55°C (the extremes included)	
Easily Flammable	R11 Easily Flammable	Liquid substance with flash point between 0°C and 21°C. Solid substance easily flammable after short contact with ignition source and continues to burn after the source has been removed.	
	R15 By contact with water develops extremely flammable gas	In contact with water or humid air substance develops extremely flammable gas in hazardous quantity (> 1 dm³/kg per hour)	
	R17 Spontaneously flammable in air	In contact with air at environment temperature without adding energy, substance can heat to flash point.	
Extremely Flammable	R12 Extremely flammable	Liquid substance with flash point less than 0° (or boiling point lower (or equal) than 35°C. Gas substance igniting with air contact at environment temp.	Same symbol as above with indication: F+

The following two labels are for reference only and indicate explosive material; in this case no further symbols like F, F+ are required. The O (Oxidizing) symbol indicates that the material acts as combustible without the need of oxygen and needs to be kept separate from flammable substances.

Figure 1: Symbols combustible and explosive substances



Although these labels are not applicable for our scope, they are of importance when substances are used for other processes and, e.g., are stored together with the refrigerants.

1.3 ATEX standards

ATEX applies to situations where flammable materials exist or are in use, specifically:

- Equipment
- Plant
- **Behaviour**

The word “ATEX” has been composed by two words: “**A**tmosphere**EX**plosive”. On a work site, in the open or in a closed space, where flammable substances in large or small quantity are present, ATEX must be followed.

It is important to emphasise that the ATEX does not necessarily regard the construction of equipment or specialised plants. ATEX is a way to understand if we find ourselves in a hazardous area and if it is necessary to apply appropriate behaviour and/or use designated equipment constructed according to ATEX.

Further on we will also look into sites with flammable substances where the features of the site, for example evacuation (ventilation), make the risk non-considerable. The equipment and machinery could therefore require less specific protection.

1.4 Directives applied to work sites with explosion risk

The ATEX directives are basically subdivided as follows:

Figure 2: Application of Directives 99/92/CE and 94/9/CE

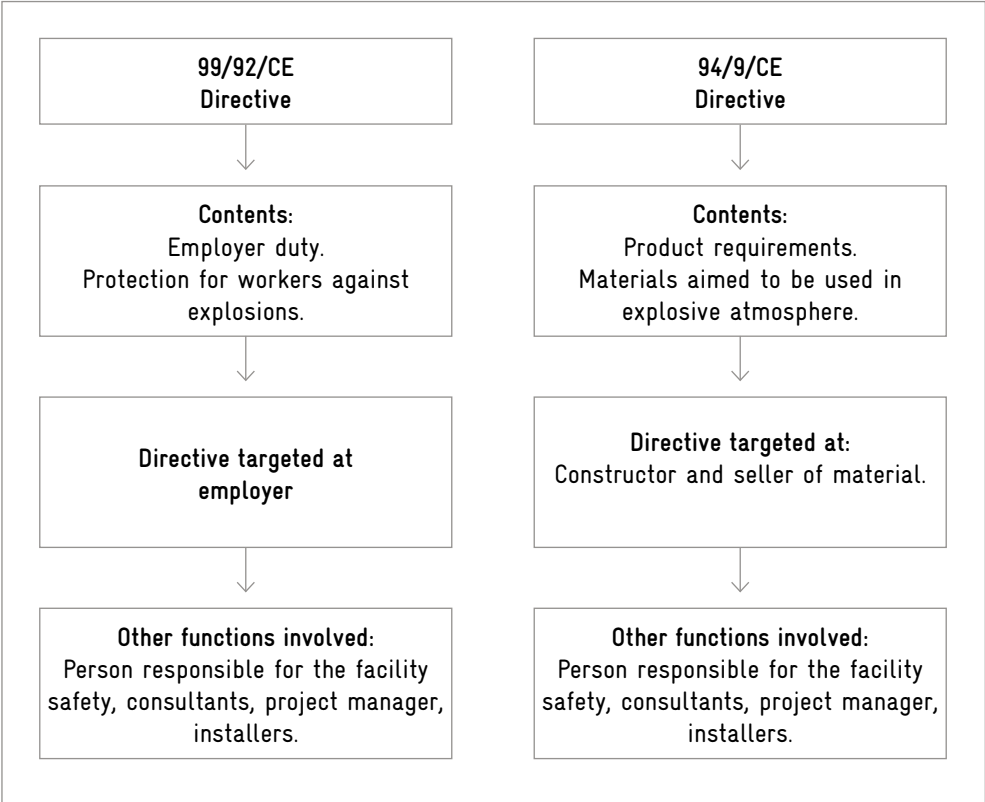

Introduction

ATEX regards all work sites where flammable substances are present, kept and/or handled. The **99/92/CE Directive** is designed for the protection of the worker whereas the **94/9/CE Directive** concerns material designed for use in potentially explosive atmospheres. It is necessary to emphasise that once the choice of a flammable substance for the production cycle has been done (in this case the apparatus for manufacturing the refrigerating cycle), the first thing to do is to evaluate where and in which way hazardous areas will appear. This is done by applying the Directive 99/92/CE, described in the next section.

Classification of hazardous areas by Directive 99/92/CE

The Directive 99/92/CE is applicable in the following way:

- a. Identifying the flammable substances used in the process
- b. Applying the Standard EN 60079-10-1 for explosive atmospheres
- c. Issuing a document in which the hazardous areas are indicated and by the function of:
 - c1. The physical state of the substance
 - c2. Frequency and duration of the presence of an explosive atmosphere
 - c3. The type and rate of ventilation

Generally the document consists of a report edited by an expert in the field accompanied by a lay-out indicating the areas defined as hazardous.

The hazardous areas are classified by the type of flammable gas⁵, vapour and/or mist present.

The areas are divided into the following three classes (zone 0-high risk, zone 1-medium risk, zone 2-low risk):

Zone 0 Area in which a consistent explosive atmosphere is present for long periods of time or frequently in a mixture of air and flammable substance in form of gas, vapour or mist.

Zone 1 Area in which the formation of a consistent explosive atmosphere in a mixture of air and flammable substance in form of gas, vapour or mist is likely to occur occasionally.

Zone 2 Area in which, during normal activity, a formation of a consistent explosive atmosphere in a mixture of air and flammable substance in the form of gas, vapour or mist will not occur. If it does, for example due to malfunction or damage, the duration is for a short period of time only.

Once the hazardous areas have been identified following the document described in the previous paragraph, the explosion risk must be evaluated.

⁵ In this document gas refers to vapor or mist.

It is important to emphasise that the European Standards regard only explosive atmosphere in air under normal conditions: pressure 0.8 Bar-1.1 Bar and temperature between -20°C and +60°C. The reason of these limits is because they are most frequently present.

Normally, explosion risks can be excluded when:

- a. No flammable substances are present
- b. Flammable substances are present but cannot develop explosive atmosphere. For example if the temperature of the flammable substances remains constantly under flash-point, or if they are not in contact with air⁶.
- c. Explosive atmosphere can develop but in reduced volume which does not constitute any risk for the personnel present.

Figure 3 illustrates a flow chart of the application of minimum safety measures at a work site.

This flow chart could induce to quickly select the option “No minimum risk prescription against explosion risk must be applied”. It must be considered that a specific analysis is required, preferably by an experienced and certified expert. A good example where measures have to be applied is e.g. that a supplier indicates that one container of a substance does not pose a risk, but the reality in the factory is that many more containers of that substance are used and that the sum of all DOES pose a risk.

The responsibility to verify whether or not the minimum prescription against explosion needs to be applied lies solely in the hands of the user and NOT the raw material supplier!

⁶ For flammable conditions see the following paragraph

Figure 3: Flow chart for minimum safety prescriptions

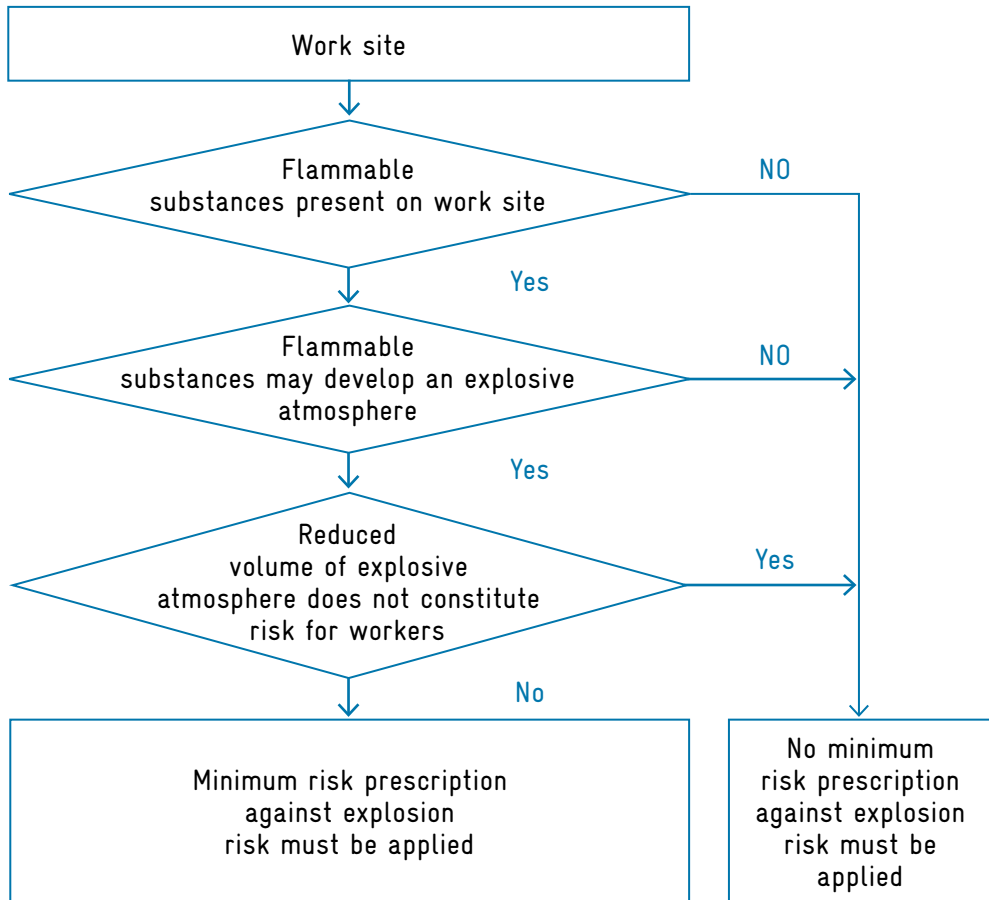

1.5 Protection for workers against explosion

The first thing to do when evaluating explosion risk is to exclude, if possible, the presence of an explosive atmosphere.

If this is not possible then an evaluation of explosion risk must be carried out. The evaluation procedure begins with the consideration of the work process and/or production process under three conditions:

- Under normal production activity;
- During start-up, technical test, etc.;
- During malfunction and predictable malfunction.

Furthermore, the following must be considered:

- Probability and duration of explosive atmosphere
- Presence of ignition source
- Predictable effect of an explosion

Analysing each consideration of explosive atmosphere

1. Probability of presence of an explosive atmosphere

Work-sites with explosive risk must be divided into areas, according to the grade of presence of explosive atmosphere, applying the EN 60079-10-1⁷ standard. The dividing procedure of the work-site into areas must be named “Classification of areas (zones) with explosion risk”⁸. When the procedure is terminated the work-site will be divided into hazardous areas:

- Zone type 0
- Zone type 1
- Zone type 2
- Zone type NON-HAZARDOUS

For Zones 0, 1 and 2 protection measures must be provided. For higher risk, more effective protection measures are required. For NON-HAZARDOUS less protection measure are required.

PLEASE NOTE: The use of ATEX directives does not necessarily mean the automatic installation of particular plants.

ATEX sometimes allows classification of some areas as non-hazardous areas, where explosive atmosphere exists but the volume of the atmosphere is limited such that it does not present any potential risk and is termed, zone of “negligible extent” (NE).

This means that if an explosion occurs the damage caused is likely to be minimal. An example is a cigarette lighter: Once you operate, the flammable gas will exit and with the spark a flame is lit. This is not particularly dangerous when used in the proper way. But many airlines prohibit lighters inside the airplane, as with many passengers the amount of lighter and flammable gas would become a potential danger.

⁷ It is not obligatory to apply the standard, other regulations can be taken in consideration. However the EN 60079-10-1 Standard permits the justification of any charges from controlling authorities.

⁸ From here on the term EXPLOSIVE ATMOSPHERE means HAZARDOUS EXPLOSIVE ATMOSPHERE

2. Presence of Ignition Source

In the context of risk evaluation, the presence of ignition sources able to ignite an explosive atmosphere must be identified. The types of ignition sources are listed in the standard EN 1127-1, chapter 5.3.

3. The predictable effect of an explosion

There are mathematical methods to evaluate the damage of an explosion and the probability that an explosion will occur. However, this document considers the damage of an explosion and the safety measures aimed to prevent explosion.

In certain cases it is even more important to prevent explosion:

- Where there is a risk of chain explosions,
- where there is a risk that an explosion releases toxic substances, and
- where the explosion site is near a residential area (here, much greater effort must be exerted into reducing the explosion risk.)

It is necessary to intensify the safety measures to avoid explosion and its consequences.

1.6 Safety measures against explosions

Safety measures against explosions must *always* be provided for if there are explosive atmospheres and ignition sources present.

The measures may be of the following types:

- A. Technical
- B. Organisational

The technical measures against explosions can be divided into:

- A1. Technical measures to prevent explosions
- A2. Technical measures to protect from explosions

In the EU it is obligatory for employers to adopt safety measures *preventing* the formation of hazardous explosive atmospheres. These safety measures are first priority before other measures.

This means that when workers are protected by barriers, e.g. a concrete wall, this protection does not substitute the safety measures. The safety measures have to be ap-

plied in any case and the barrier is an additional safety precaution but does not substitute the measures!

Technical measures to prevent explosions

Prevention measures help to avoid the formation of explosive atmospheres. The formation can be avoided by the following rules:

- replacing flammable substances with other substances
- keeping flammable substances below lower explosion limit (LEL)
- keeping flammable substances below their flash-point temperature
- limiting the areas where substances may be in contact with air (oxygen)

Safety measures to avoid ignition sources

To avoid the ignition of an explosive atmosphere, it is necessary to identify the ignition sources present and to adapt the necessary protection measures to such an extent that no ignition can occur. The use of materials allowed by the Directive 94/9/CE, which means materials adequate for the type of hazardous zone in which they are installed, will guarantee that such material does not contain ignition sources.

The ignition sources can be identified and eliminated by following the standard EN 1127-1, further described in chapter 6.3 and 6.4.

Technical measures to protect against explosions

The technical measures for protection provide limitation of the explosion effects to the extent that the explosion will no longer pose any danger. Protection measures can be synthesized as follows:

- Suffocating the explosion: By adequate actions, create an inert or oxygen free atmosphere.
- Discharging the explosion: By the use of specific equipment, the products of the combustion will be discharged in the open air. This action limits over-pressure to avoid stressing the structural limits, e.g. of a container.

1.7 Organisational measures against explosions

The organisational measures can be synthesized as follows:

- Qualification of the personnel
- Adequate training in explosion protection
- Operational instructions
- Work authorisation
- Caution during maintenance operations
- Signalling explosion risk areas
- Control and surveillance

Qualification of the personnel

Workers assigned to work in hazardous areas must have adequate training and experience in protection against explosions. This also applies to workers from subcontracted companies.

Training of personnel

Workers must take part in an appropriate training course with at least a minimum level of knowledge in the following:

- Information regarding explosion risks
- Description of work areas where explosion risks are present
- Applied preventive safety measures and the functioning of the safety measures
- Correct use of work equipment
- Information, instruction and knowledge to execute “in safety” the work in hazardous areas
- List of equipment
- Mobile protection equipment in hazardous areas
- Personal protection equipment to be used during work in hazardous areas

The training must also be provided to workers on certain occasions:

- New recruitments, before start working
- Transfer or assignment of different activity
- Introduction of new equipment (or modifications of the already existing equipment) or the introduction of new technology

Operational instructions

The term “Operational Instructions” in this context means procedures in written form established by the person in charge. The Operational Instructions must contain:

1. User instructions
2. Norms of behaviour

The instructions must be written for the worker in a comprehensive language. Furthermore, the instructions must indicate:

- A list of equipment
- Mobile protection equipment in hazardous areas
- Personal protection equipment to be used during work in hazardous areas, e.g. anti-static garments

Specific caution during maintenance

Experience teaches that during maintenance operations the risk of accidents increases, especially those related to explosions. A particular attention during maintenance operations is therefore of extreme importance.

In situations where external companies are called in to perform maintenance operations, it becomes even more important to check the following parameters:

- No explosive atmospheres are present that can be ignited by maintenance work (for example welding, cutting, etc.);
- When the maintenance work is finished, before starting up the machinery/equipment, the reactivation of protection measures is done (protection measures are often deactivated during maintenance);
- The person in charge of the department must check that maintenance work has not damaged or caused any malfunctions to the safety measures. For example, re-establish functionality of e.g. gas detector and/or cleaning the gas detectors with solvent liquid if necessary.

Explosion risk area signalling

The explosion risk areas must be indicated by warning signs.

The warning signs must be accompanied by information such as:

- Type of flammable substance in use
- Type of hazardous area

Once the explosion risk area has been established, it is wise to mark the area limits on the floor by a broken line painted in yellow and black with the sign “EX”, as shown in Figure 4.

Figure 4: Symbol to indicate ATEX area

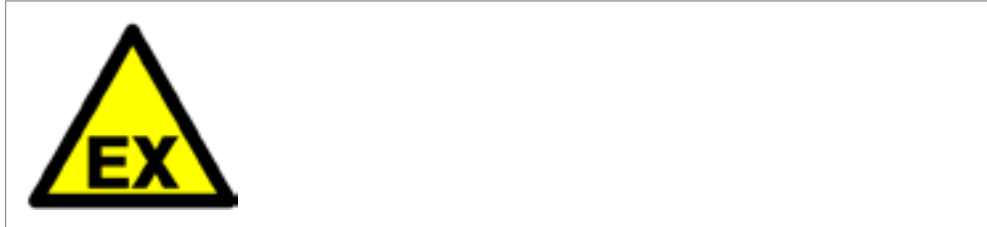

Work authorisation

Whenever extraordinary work such as maintenance must be performed, it is important to issue the necessary work authorisations. The most common work provoking accidents (fire or explosion) is welding.

It is therefore necessary to work out a system of work authorisations in written form. For example, a pre-printed form should be filled in by internal personnel or the external company performing the work. All personnel involved in the work must sign the form⁹ (an example can be found in Table 2).

On the authorisation form, at a minimum, the following information must be included:

- Identification of the areas where the work will take place
- Names of personnel performing the work and the person in charge of the areas where it will take place
- Work start and predicted finishing dates
- List of protective measures to adapt

Control and surveillance

It is important to check the equipment in the explosion risk areas:

- before starting-up
- in situations of malfunctioning
- scheduled regularly, the frequency depends on the safety measures adapted

⁹ It is wise filling in the form together with the insider discussing the operation procedures

Table 2: An example of a work authorisation form used by Italian firms

Work Authorisation Sheet With ignition sources in hazardous areas	
Work site Department or areas involved
Type of work, e.g. welding, air fan repairing
Type of work	<input type="checkbox"/> Welding <input type="checkbox"/> Cutting <input type="checkbox"/> Other <input type="checkbox"/> Grinding <input type="checkbox"/> Use of forklift <input type="checkbox"/> Fusion <input type="checkbox"/> Use open flames
Precautions to adapt before starting the work	<input type="checkbox"/> Make sure no explosive atmosphere is present <input type="checkbox"/> Remove combustible and mobile objects and substances <input type="checkbox"/> Remove accumulated dust at range ofm. <input type="checkbox"/> Cover non-mobile flammable objects with protection materials, e.g. wooden floors and walls, plastic radiators, etc. <input type="checkbox"/> Seal grids and similar openings with non-flammable material <input type="checkbox"/> Eliminate explosive atmosphere in containers and ducts (involved in the work), e.g. by by-passing or cleaning. If this type of work must be performed a separate work authorisation must be issued with detailed instructions.
Fire fighting equipment	<input type="checkbox"/> Extinguisher <input type="checkbox"/> Water <input type="checkbox"/> CO ₂ <input type="checkbox"/> Dust <input type="checkbox"/> Fire hose connected and ready <input type="checkbox"/> Person(s) in charge of safety and/or fire fighting Name:..... Name:.....
Fire guard	<input type="checkbox"/> Provision for fire guard service Position of the nearest fire alarm..... Tel. number of the fire brigade.....:.....
Date:..... Person in charge or delegated signature Person performing the work signature

For example, the control and maintenance of electrical equipment and plants in explosion risk areas can be done by checking the presence of gas/vapour/mist. See standard EN 60079-17.

Checking must be performed by technically trained personnel with experience in the field of explosion protection.

In the following pages, Figures 5 and 6 will summarise the previous paragraphs.

Figure 5: Logic for explosion risk assessment

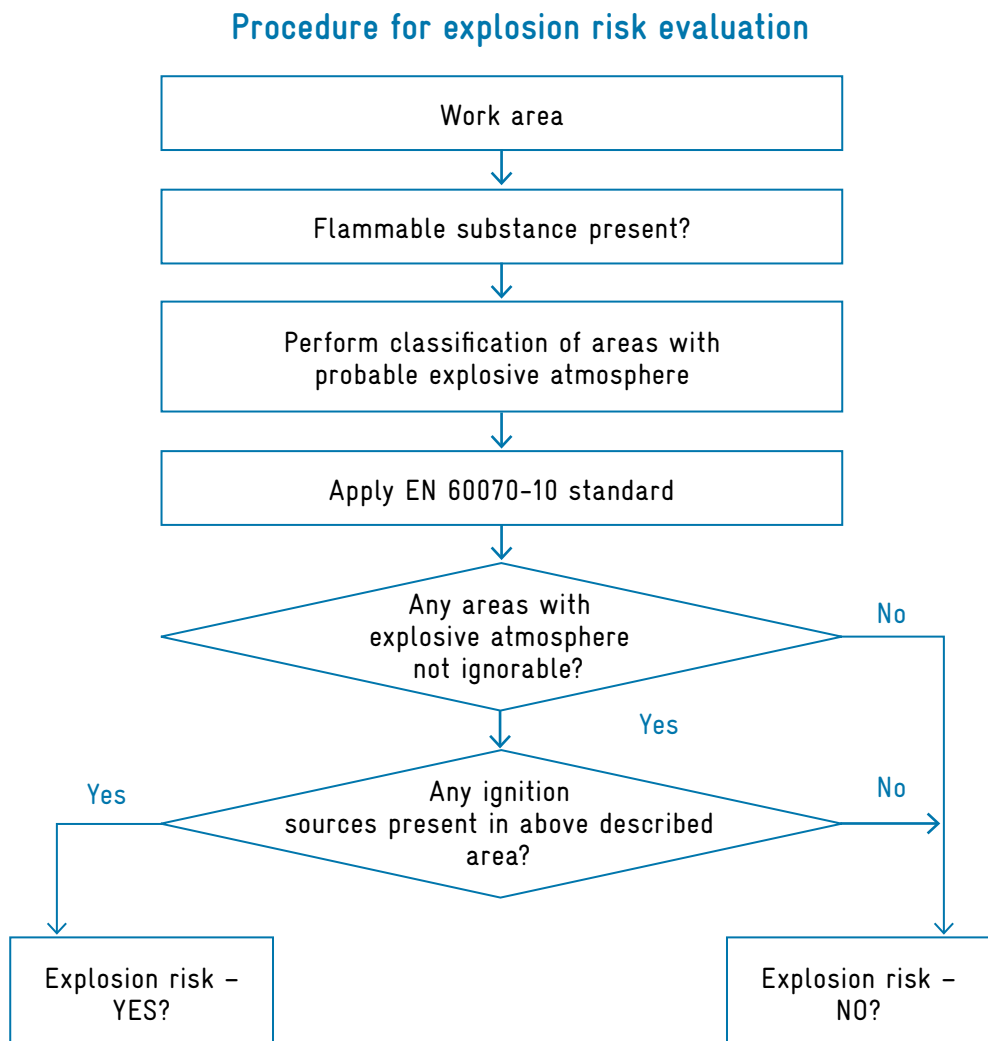
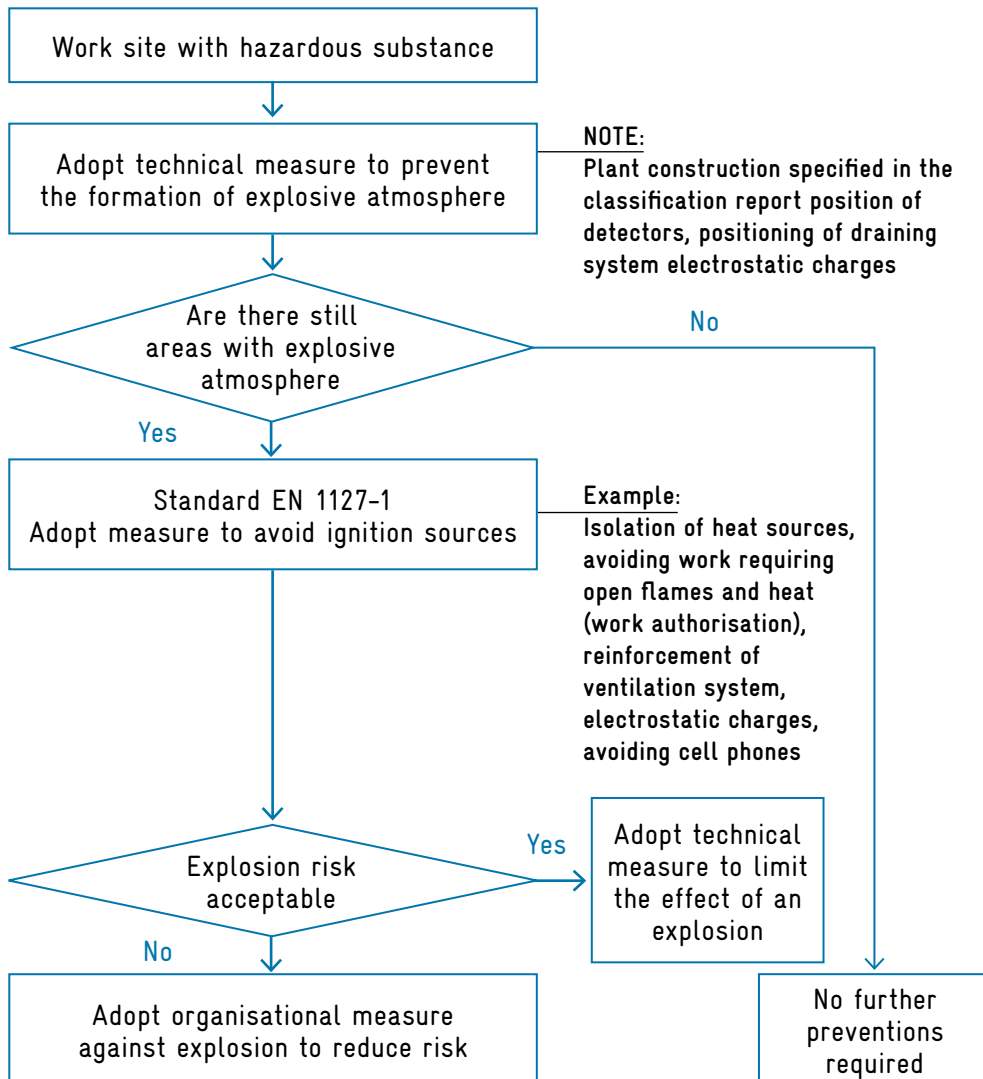

Figure 6: Technical organisational protection measures

Technical and organisational protection measure against explosion



1.8 Conformity of equipment by applying directive 94/9/CE

Introduction

By identifying and understanding the problems with the use of flammable substances inside the facility, it is important to apply the equipment and machinery suitable for the hazardous areas.

It is important to understand that with the choice of materials that conform to the 94/9/CE Directive and are adequate for the hazardous area in which they have been installed, it is guaranteed that:

- Such products will not create ignition sources
- If no special ambient conditions exist, it is not necessary to evaluate the reliability of the product; this has already been done by the manufacturer. By fixing the obligatory machine plate with the ATEX marking on the equipment and enclosing the declaration of conformity in combination with the user's manual, the product is guaranteed.

How to understand the conformity of a product

Understanding the conformity of a certain product means to understand if a product is appropriate for installation in a hazardous area (Zone 0, Zone 1 or Zone 2). For this the following information must be sought:

For the conformity evaluation of a product, by using the Directive 94/9/CE, the manufacturer is forced to follow a procedure that is severe and with a higher classification than the area in which the product will be installed. In this context, the word "equipment" includes safety devices, both for control and for regulation, and components.

Equipment to be installed in hazardous areas defined by ATEX bears the following marking: one number + one letter. The equipment is divided into three categories:

- Category 1 equipment
- Category 2 equipment
- Category 3 equipment

The letter that follows can either be:

- “D” (dust) for installation in areas that are hazardous due to gas or dust, or
- “G” (gas) for installation in areas that are hazardous due to gas/vapour/mist

In the present case we must always use the letter “G” (gas) due to the treatment of gas, vapour and mist.

Category 1G equipment (Cat. 1G):

Cat. 1G equipment is appropriate for installation in Zone 0 in the presence of gas. The equipment must have an EC-Type certificate issued by an appropriate authority. Furthermore, the manufacturer must use an approved quality system for the production, perform inspections following the national directives and be audited by the appropriate authorities required by the directive (Form: “Production quality guarantee”).

Category 2G equipment (Cat. 2G):

Cat. 2G equipment is appropriate for installation in Zone 1 in the presence of gas. The equipment is divided into the following sub-groups:

1. Electrical equipment or combustion engines

The equipment must have an EC-Type certificate issued by the appropriate authority. Furthermore, the manufacturer must use a quality system approved by the appropriate authorities. The manufacturer must declare, under the control of appropriate authorities that the product conforms with the approved prototype (Form: “Type Conformity”).

2. Non electrical equipment

It is not necessary for the equipment to go through the CE exam performed by appropriate authorities. It is sufficient that the manufacturer provides the technical documentation proving the conformity of the equipment (Form: “Internal Manufacturing Control”). This documentation must however be handed in to the appropriate authority.

Category 3G equipment (Cat. 3G):

Cat. 3G equipment must be installed in Zone 2 in the presence of gas. No CE exam performed by appropriate authorities is required. It is sufficient that the manufacturer provides the technical documentation (Form: “Internal Manufacturing Control”).

Equipment to be installed in a production line and/or pumping/batch plant must be accompanied by a certificate from an independent verification institute.

Figure 7: Typical CE marking plate

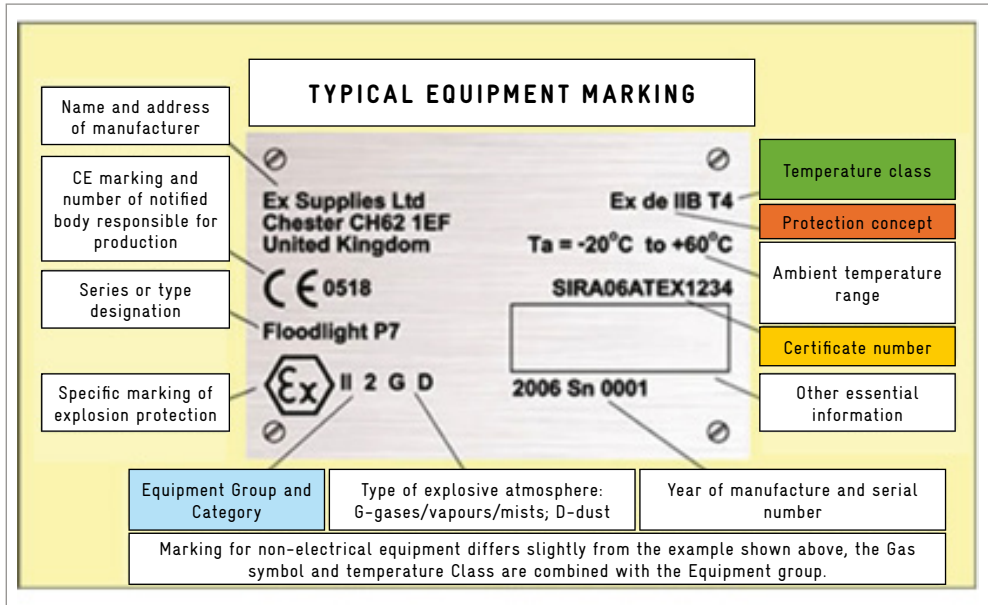



Figure 8: CE Certificate Example

	CE CERTIFICATE
[1] TYPE EXAMINATION CERTIFICATE	
[2] Component destined for use with apparatus or protective systems intended for use in potentially explosive atmospheres	
Directive 94/9/CE	
[3] Number of Type Examination Certificate:.....	
[4] Component:.....	
[5] Manufacturer:.....	
[6] Address:.....	
[7] This component and its acceptable variations thereto are specified in the schedule to this certificate and the documents therein referred to.	
[8] (Name and reg. no. of appropriate authority)in accordance with Article 9 of 94/9/CE of the EU Council Directive of 23rd March 1994, certifies that this component has been found to comply with the essential health and safety requirements relating to the design and construction of equipment and protective systems intended for use in potentially explosive atmospheres as described in Annex II to the Directive.	
The examination and test results are recorded in the confidential Assessment and Test No	
[9] Compliance with the essential health and safety requirements is ensured by compliance with:	
EN 60079-0:2006	EN 61241-0:2006
EN 60079-11:2007	EN 61241-1:2004
[10] The symbol “U” placed after the certificate number indicates that this certificate must not be considered as certificate for apparatus or protective systems. This partial certificate can be used as a base for certificate for apparatus or protective systems.	



CE CERTIFICATE

[11] This CE Type Certificate relates only to the design and construction of the specified apparatus or protective system in accordance with Directive 94/9/CE. Further requirements of this Directive apply to the manufacture and supply of this component. These requirements are not covered by this certificate.

[12] The marking of the component must include the following:

II 2 GD Eex IIC IP 66/67

This certificate, attachment included, can only be reproduced in full and without variation.

Date of Issue:

Processed
(Name, Surname)

Approved
(Name, Surname)

All these procedures result in providing with the equipment:

- A. One label fixed on the equipment
- B. One certificate (manufacturers declaration of conformity) to accompany the equipment
- C. The user manual

The above mentioned CE certificate and CE label on the equipment have to be issued for all the categories.

There is however a difference between the categories and the instance who issue the certificate:

- For Cat. 1 and Cat. 2 electrical equipment and motors, the certificates have to be issued by a certified authority e.g. TÜV, Veritas, SGL, VDE, etc.
- For Cat. 2 non-electrical equipment and Cat. 3 the equipment supplier is issuing the certificates.

For all the certification issued by the supplier or certified institute, copies of the documentation proving the proper build as according to the category have to be kept in the supplier premises; for verification by end-users or other organisations in case of need.

2. SUBSTANCES IN USE

2.1 Introduction

The refrigerants used in air-conditioners and heat pumps are for example:

- HC R600a
- HC R290
- HC R1270
- HFC R161
- HFC R32
- HFC 1234 yf¹⁰

When used, the plant therefore requires conformity to ATEX directives. This is independent from the amounts used, or whether they are used in mixtures to reduce the flammability level and/or other methods to reduce the flammability. The responsibility in all cases lies in the hands of the user of the products and not the producer of the blowing agent.

It is emphasized that it is necessary to carefully verify blends since in many cases, due to different boiling points, the components can separate. Even if a mixture may be non-flammable, single components may be flammable.

2.2 Behaviour of liquid and gaseous products

Vapour Pressure:

Evaporation occurs at the surface of a liquid. If the surface is exposed to the atmosphere, evaporation generally occurs continuously. If, however, the surface is within an enclosed space, evaporation will occur only until the air within the enclosed space becomes saturated with vapour. The vapour pressure and the extent of vaporisation depend on the temperature of the liquid. When the pressure in an enclosed cylinder reaches the vapour pressure of a specific liquid no further evaporation will occur. Further evaporation will only occur when the liquid or vapour is removed from the container and therefore the pressure lowered.

¹⁰ This substance is being considered for use in automobile air conditioners.

When there is a container, cylinder or drum, equilibrium will be created between the liquid and gas phase of the substance. This means that when liquid is retrieved the space created will be filled with vapour. At the end, after all the liquid has been removed from the container, cylinder or drum will be entirely filled with vapour.

The refrigerants used in the production of air conditioners are low boiling point refrigerants, supplied in pressurised bottles.

The fluids are in gas phase at 20°C (in this case the supplier provides the liquefying of the product in order to supply the product in liquid state) and liquids are used at higher pressures.

At an environmental temperature of 20°C and standard atmospheric pressure, HFC-1234yf and R600a are in vapour phase. The liquefying of a gas is a function of the boiling point temperature. The lower the temperature, the higher the pressure must be to reach liquid state and vice versa. The pressure will be higher for a storage container, cylinder or tank with lower boiling point refrigerants used at higher temperatures. The liquid containers with refrigerants with boiling point temperature less than 20°C will be sealed and under pressure while refrigerants in containers with boiling point temperature above 20°C can be stored at atmospheric pressure.

Specific weight:

This is the relation between the weight of a certain volume of liquid at 15.5°C (60°F) and the weight of the equal volume of distilled water at 4°C (39.2°F) and 760 mm Hg.

Gas specific weight:

This is the relation between the weight of a certain volume of gas in dry state and the weight of an equal volume of dry air at 0°C and 760 mm Hg.

The specific weight of a liquid and a gas:

This is the weight of a volume unit expressed in kg/l or kg/m³ or g/cm³. The specific weight of water is 1 (1l of distilled water at 4°C is 1 kg). Therefore the “specific weight” is represented by the same number.

The relation between the weight of 1 m³ of the product in liquid phase and the weight of 1 m³ in vapour phase gives the quantity of vapour that can be obtained from 1 m³ of liquid.

For isobutane (R600a) for example, we have¹¹:

- 1 m³ of isobutane in liquid phase weighs 563 kg
- 1 m³ of isobutane in vapour phase weighs 2.45 kg

The relation gives: $563/2.45 = 229 \text{ m}^3$

From 1 m³ in liquid phase we will have 229 m³ in gas phase.

This result shows that 1 litre of isobutane in liquid phase poured in a certain area (for example a production department) occupies a volume of 229 litres.

This volume of vapour has a tendency to mix and spread throughout the entire volume of a space creating an explosive atmosphere. Considering the Lower Explosion Limit (LEL) of isobutane (R600a), which is equal to 1.8% vol, it equates to:

- 1 litre of isobutane in liquid phase = 229 litre of vapour
- 229 litre of vapour will create a situation of LEL for a space with the volume of 12,722 litre ($229:0.018 = 12.7 \text{ m}^3$)
- When we consider a typical alarm of sensors at 15% of LEL, the alarm is triggered at a volume equal to $(229: 0.018) \times 15\% = 1.91 \text{ m}^3$

This helps us understand the danger of even a small release of refrigerant. In a very short time span, situations of potential danger for an entire space can be created.

It is also important to note that the cases examined in this document are treated in the same manner as they would be gas, vapour or mist. In fact a gas can be distinguished from vapour or mist because it follows the Ideal Gas Law: $p/v \cdot m \cdot R \cdot T = \text{constant}$, where:

- p = pressure
- v = occupied volume at a constant temperature
- m = mass of substance
- R = Universal gas constant
- T = absolute temperature.

Vapour and mist do not follow the Ideal Gas Law. Furthermore, the law is only applicable to ideal gases and not to those gases which we are treating. For our reasoning, we may however consider a gas being real if it is being used far from its point of liquefying, with the approximate application of the Ideal Gas Law.

¹¹ Specific weight at 15°C and standard atmospheric pressure

Even though gas, vapour and mist are treated the same way, from the safety point of view, it must not be forgotten that it is the result that counts, which is the creation of a potentially explosive atmosphere in case of leakage or damage.

Furthermore all refrigerants used in this field are heavier than air, or more precisely, in atmospheric pressure and environment temperature they have the tendency to stratify towards floor level.

This will increase the potentially explosive area indicated in the previous example, as a function of the geometrical disposition of the plant. This means that there would no longer be a cube with a given volume but a cloud with a decreasing height spreading throughout the space.

Potentially explosive atmosphere

Even if there is a presence of a hazardous substance free flowing due to leakage or damage, which can provoke an explosion, the following circumstances must occur at the same time:

- a. the substance must mix with oxygen in the surrounding air in appropriate proportions
- b. the mix must be ignited by a spark, arc, naked flame or hot surface

Gas, vapour and mist are therefore considered flammable if they are mixed in appropriate proportions with oxygen and may cause an explosion¹².

2.3 Fire triangle

Figure 9: The fire triangle

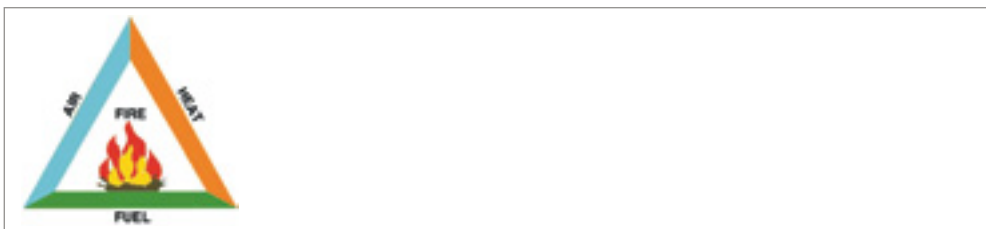

For an explosion to occur there must be three components present at the same time:

¹² It is important to consider the difference between the gases apart from explosive substances; the last ones contain both combustible substance and comburent and therefore may explode in absence of oxygen.

- a. Combustible or fuel, representing the substance
- b. Oxidator, the oxygen in the surrounding air¹³
- c. Ignition source¹⁴

For an explosion to occur, flammable material and air must be mixed in precise proportions called Explosion Limits (EL).

2.4 Explosion limits

Explosion limits or flammability limits of a gas or liquid vapour are limits identifying the range of concentration in which, if the mixture of air-vapour or flammable gas is ignited (by a spark, for instance) a combustion of the mixture takes place. This combustion can be in the form of an explosion, deflagration or just a fire, depending on various factors (concentration of combustible first of all, type of container, etc.). The range of the explosion is limited by a minimum and a maximum percentage of combustible in the air (or less frequently, other combustible agents). These percentages are so-called Lower Explosive Limit (LEL) and Upper Explosive Limit (UEL), and provide the range in which a combustion can occur:

- For concentrations below LEL, there is not enough combustible for propagation of the flame
- For concentrations above UEL, the atmosphere is saturated with flammable material (not enough air) and there is no oxygen for the propagation of the reaction¹⁵.

The situation of concentrations over UEL is typical for a tank containing flammable liquid, for example petroleum, solvents, pentane, etc., stored at atmospheric pressure. The vapour developed by the flammable liquids makes the atmosphere constantly saturated and therefore above the UEL, but will nevertheless be considered as Zone 0. Unfortunately this can change during filling /emptying processes or during maintenance. In general, the use of UEL should be handled with special attention.

Controlling the concentration of gases and vapours is in fact one of the main problems in the field of safety that will be addressed within the following chapters. In some cases of elaborations to reduce the concentration of one gas that is extremely explosive, inert gases (like nitrogen) can be used to replace air (oxidator) to make the mixture less hazardous. This operation is called “inertisation”.

¹³ The air that surrounds us contains approx. 22% oxygen.

¹⁴ The EN 1127-1 identifies 13 different types of sources potentially efficient.

¹⁵ There are cases of aborted explosions that have been proved hazardous. E.g. inside storage tanks of inertised (by use of the saturation system) flammable liquid.

Important measurements

Flash point:

The flash point is the minimum temperature at which, at atmospheric pressure, a substance, generally liquid creates vapours with concentrations within the limits of flammability.

It is understood that:

- a. if the flash point is above the environmental temperature or operating temperature the probability of an ignition to occur is low.
- b. if the flash point is low the ability for the substance to ignite is high.

Auto Ignition Temperature:

The auto ignition temperature is the minimum temperature at which ignition may set off explosion or combustion. It must be ensured that the protection is from both, explosion and combustion.

For more detailed information on the measurements and characteristics please refer to the GIZ Proklima publication "Guidelines for the safe use of hydrocarbon refrigerants", September 2010.

2.5 Material Safety Data Sheet

A material safety data sheet (MSDS) provides all the required information mentioned in the previous sections. These MSDS must be provided by the supplier and approved by certified institutes.

3. ATEX AREA

3.1 Hazardous areas

The hazardous areas/zones within the facility consist of the areas where flammable substances are in use or stored or where they could be transferred to. This paragraph regards plants with production cycle quantities for each apparatus between 300 and 1000 grams only.

The flammable substances, in this case refrigerating liquids, are always stored in cylinders or tanks, in most cases pressurised. There may be cylinders with a small volume of some litres or/and cylinders with a greater volume up to thousands of litres.

The liquid R600a (isobutane) may come in containers of various sizes:

- Tank of 15 kg (approx. 30 l)
- Tank of 500 kg (approx. 1000 l)
- Built-in tanks with volumes between 1000 l and 5000 l

In the last case the loading must be performed by special equipped tank trucks. Consequently, inside the facility there will be zoned areas in the following sites:

- Storage area for flammable gas
- Distribution system for flammable gas to the various user plants
- Gas injection system for compressor
- One or two analysing stations (test)
- One cabin for performance testing
- Storage area for finished products
- Depending on transportation and handling conditions the lines between the above mentioned areas can also be ATEX areas.

The above listed areas, more or less hazardous, must be evaluated under ATEX.

Hazardous areas in facility

The safest and easiest way to classify the sites is to apply the standard EN-60079-10-1:2009 – “Electrical apparatus for explosive gas atmospheres part 10 classification of hazardous areas”.

To obtain a precise application of the standard, in order to specify exactly where in the facility the hazardous areas can be found, it will be necessary to engage an expert

in the field whom will:

- apply the EN-60079 standard
- consider all conditions: chemical, climatic, geometrical and topographical of the facility
- edit a project

3.2 Identifying methods for hazardous areas

Identifying methods for hazardous areas as follows¹⁶:

Referring to chapter 1.4, it is known that ATEX identifies three hazardous zones for gas:

- Zone 0
- Zone 1
- Zone 2

It is important to emphasise the following:

- Classification of the *area* is defined by the presence of hazardous substance
- The *area*, identified both as *risk level* and as *geographical area*, is determined by:
 - The sources emitting or which may emit hazardous substances in the environment.
 - These elements are called “Emission Sources” (ES).

In order to identify the hazardous areas we must be identify and classify the following:

- Emission Sources (ES)
- Openings
- Ventilation (level and availability)

¹⁶ For a more thorough examination of the matter see standard EN-60079-10-1.

A) Emission Sources (Annex A of standard)

The emission sources can be classified in three levels:

1. Continuous grade, also named level 0: Source continuously emitting hazardous substance for long periods of time, e.g. from the relief valve of a tank.
2. First grade: A source emitting hazardous substance periodically or occasionally *during normal operation*. A typical example may be loading valve or unloading valve of a mixer in use only for a few minutes per day. In our case, situations like degassing of the injection pipe connectors of the charging equipment.
3. Secondary grade: A source not emitting hazardous substance during normal operation but could, in case of damage, emit hazardous substance. A typical example can be a flange with sealing, where in normal operation no release of flammable substances is expected, or e.g., the inside of ventilation ducts.

B) Openings (Annex A of standard)

In this case “openings” means doors, windows and every passageway through walls, e.g., passageway for piping. The openings are important for the classification of the environment due to the fact that they represent a way for the hazardous substance to spread from one space to another.

The openings can be divided into four types:

Figure 10: Example of Type A opening

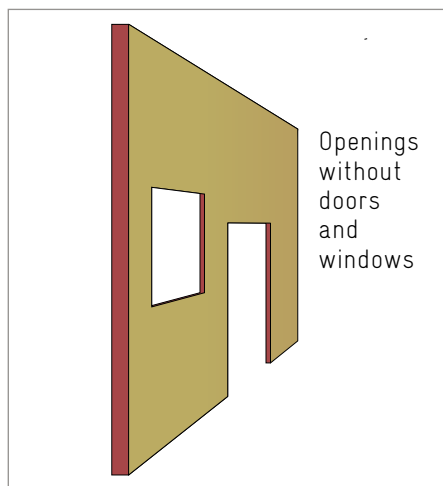

1. Type A

Opening without closure (door, hatch), open frequently or for long periods of time. Passageways for cables and piping are considered Type A, when these passages are not sealed.

Figure 11: Example of Type B opening

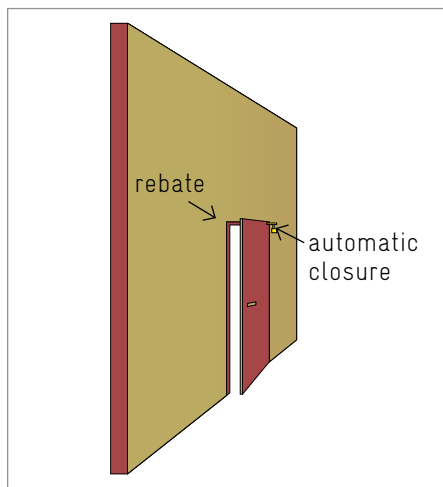

2. Type B

Opening with sealing on all sides e.g., door with interspace of not more than 1 mm between door and threshold, not opened frequently and that cannot stay open due to automatic closure.

Figure 12: Example of Type C opening

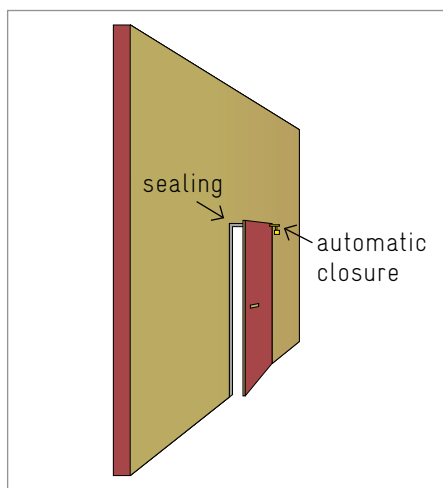
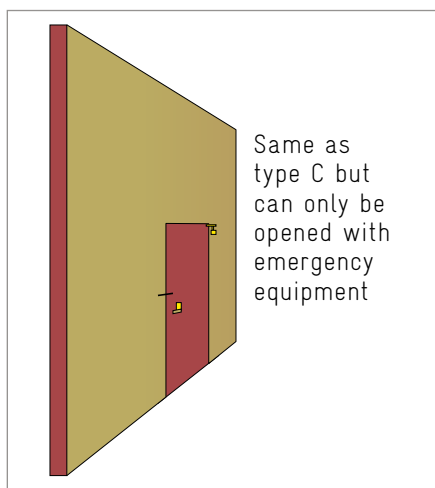

Figure 13: Example of Type D opening



3. Type C

Opening with double or tight sealing on all sides.

4. Type D

Opening with same features as Type C but possible to open only with special equipment or in case of emergency. This type of opening can be obtained by combining Type C opening, next to hazardous area, with Type B opening.

It is understood that opening Type A does not limit the level of classification of the area. The hazardous area and the area next to it connected by a Type A opening must have the same classification.

The Type B opening is normally the passage from one hazardous area to another less hazardous area. If the area where the emission source is positioned is classified Zone 0, for zoning of the other side an emission grade of primary has to be considered.

An opening Type C means passage in two steps: If the zone is 0, on the other side of opening, emission grade secondary should be considered.

An opening Type D means passage in three steps. If the zone is 0, on the other side of the opening there is “no emission source”.

If on the one side is Zone 1, the emission grades for the other side can be lowered by one step.

Summarising the openings of a room, the adjacent room or area is then classified as follows:

Table 3: Summary of openings and classification

Opening type	Zone classification of the room	Adjacent area
A	0	0
B	0	1
C	0	2
D	0	Non-hazardous

C) Ventilation (Annex B of standard)

The ventilation system is extremely important for the identification of the level of hazardous atmospheres potentially explosive (In the following sketches the blue/green colour is the emission distribution inside the room). The standard regards three levels of ventilation grade and three levels of availability that form the efficiency of the ventilation system:

Ventilation grades

1. Low ventilation (LV)

A ventilation system with fresh air-flow not able to dilute the flammable substance in order to reach LEL (Lower Explosion Level). In this case the flammable region occupies the entire volume of the closed environment with the tendency to extend the area through openings.

When the emission ceases, the environment may remain hazardous for some hours due to limited dilution of the hazardous atmosphere.

2. Medium ventilation (MV)

A medium ventilation is a system that is able to dilute the flammable substance in order to reach LEL at a limited distance from the ES (Emission Source). In this case the flammable region does not occupy the entire volume of the environment but is limited to some volume of space around the ES. When emission ceases the flammable mixture, it dilutes within a relatively short time (approximately 10 min).

Figure 14: Low ventilation

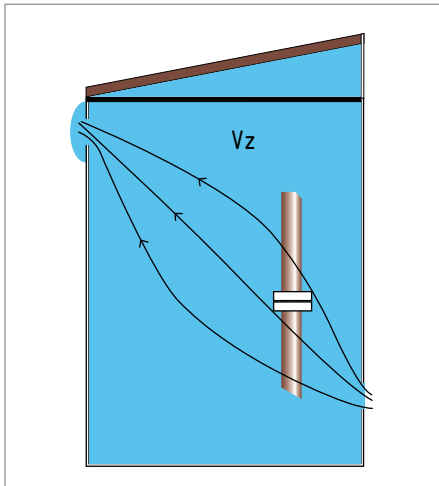

Figure 15: Medium ventilation

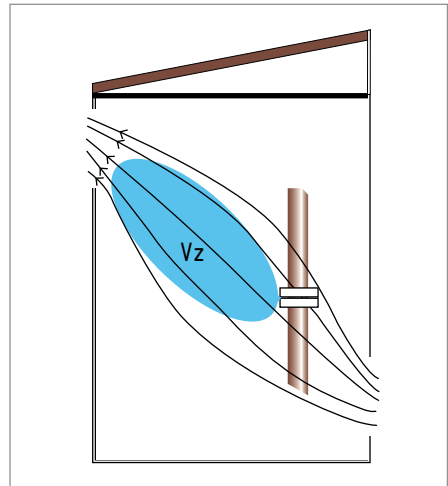
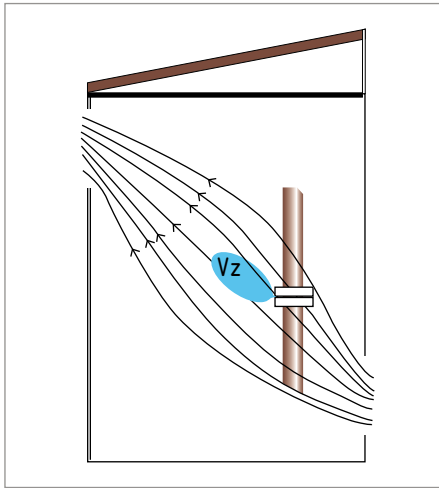

Figure 16: High ventilation



3. High ventilation (HV)

A high ventilation system is able to maintain a low concentration of the flammable substance, below LEL. The explosive atmosphere in this case is concentrated around the ES at a radius of approximately 10 cm. When emission ceases the flammable mixture, it disperses within a few seconds.

Ventilation availability

Furthermore, besides the ventilation grade, the ventilation availability must be evaluated, i.e., ensuring that a constant air flow is maintained to some extent. This availability is classified by the following degrees:

Good availability: Ventilation is continuously present with constant air flow. No interruption allowed during operation. Always applicable to open space or closed space without closures (doors, windows).

Fair availability: Ventilation is continuously present with constant air flow. Short interruption allowed during operation.

Poor availability: Ventilation does not respect the previous criteria, however, there is some dilution of the hazardous atmosphere.

When it is not possible to obtain the level **poor availability**, the environment must be considered “**Not Ventilated**”.

The standard emphasizes that the definition of the ventilation level is to consider not rigid, it leaves some space to the designer of the facility to evaluate the ventilation, considering of course the general concept of safety.

In general, the target should be for **good ventilation as minimum, meaning a high ventilation (HV) with a minimum of good availability**.

An overview is shown in Table B.1 of the EN 60079-10-1:2009 (Appendix 2).

The classification of good-fair-poor availability of ventilation is not a real technical measure. Therefore, when a ventilation system is installed it is advisable to verify that around the area of emission a good availability is present. For this purpose smoke generators are excellent tools to verify that although a high ventilation is installed it actually also removes the smoke from the emission source. However, it must also be borne in mind that smoke is neutrally or positively buoyant, whereas the refrigerant vapour under consideration is negatively buoyant. Therefore there are special smoke generators e.g. from Dräger that simulate this behaviour.

3.3 Classification of zone

The zones are classified by using three parameters:

- Source level
- Ventilation level (HV – MV – LV)
- Ventilation availability

The extension of the zone is defined by:

- The volume of the department in which the ES is positioned
- The presence and the type of openings to the other departments

The ES always generates an area connected to the level of emission:

- **Continuous = Zone 0**
- **Primary = Zone 1**
- **Secondary = Zone 2**

When the level of ventilation is high and with good availability the zones are of negligible extent (NE).

The zones are named:

- **Zone 0 NE**
- **Zone 1 NE**
- **Zone 2 NE**

In this case the zones do not affect the classification even though a good practice is to avoid ignition sources in the proximity.

When the zones are classified NE the classification is only valid for when the conditions under which the analysis has been done are present. When changes are applied to the area, e.g. additional equipment, modifications, the analysis has to be repeated and verified. It is therefore common practice to have equipment in this area suitable for Zone 2 also when not strictly required by ATEX. Therefore, if there is a temporary removal of the Zone NE classification, it does not introduce any hazard. A temporary removal is in no case advisable as it has a direct impact on the adjacent zones, see the previous paragraph!

When the ventilation is low, some partial volumes of the environment must be evaluated. For example, underground shafts may have to be classified Zone 0 (in case of gas heavier than air) even if in normal case the zone would be classified as 2. It must also be considered whether a small leakage, e.g., at the refrigeration gas injection station, could accumulate in an underground shaft and create an explosive atmosphere and ignite by electrostatic discharge or welding.

3.4 Examples of a standard installation classification

The examples can be viewed in the flow chart presented in Figure 17. A detailed description of the examples is provided in the following sub-sections.

Storage area with fixed pressurised tank

The following zones can be identified:

The tank which is installed in the open air, positioned and fixed on a supporting structure

gives:

- medium ventilation level and
- medium ventilation availability.

The ES which is created by:

- manual valves and by the safety valve positioned on the tank,
- loading nozzle,
- pump seal in the low pressure pumping station,
- feeding line

gives:

The emissions will occur only for short periods of time and with low frequency. This means that the ES are not predicted during normal operation and consequently evaluated as emission of secondary grade.

1. Medium ventilation level
2. Medium ventilation availability
3. Secondary grade emissions

Result: The area is classified Zone 2.

Figure 17: Procedure schematic for area classification

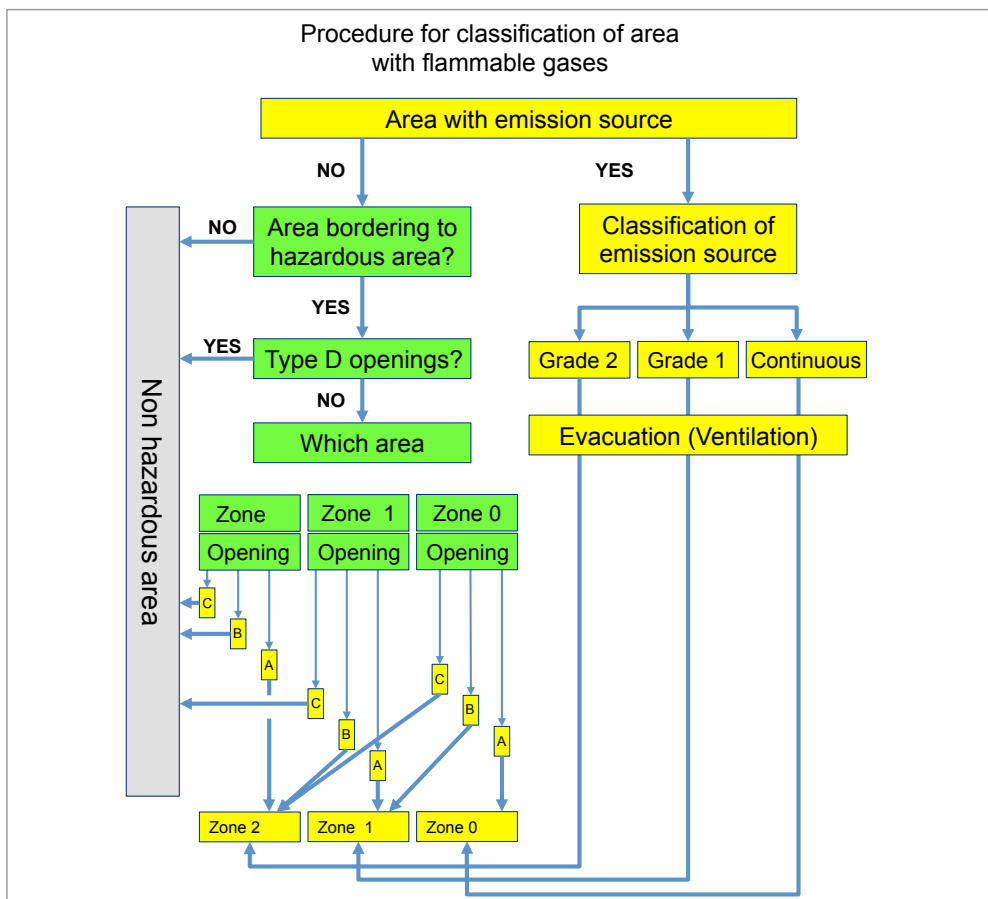

Indoor storage room for gas cylinders

The cylinders are stored in a *ventilated* storage room with Type A outgoing openings. The ES are manual valves, flexible pipes, and pump sealing in the low pressure pump station.

These emissions can occur only with low frequency and for short periods of time, this means ES are not predicted during normal operation and therefore evaluated as ES of secondary level.

Gives:

- Ventilation level Medium
- Ventilation availability Good

Result: Hazardous area is 2.

Pumping plant

Same considerations as above described.

Result: Hazardous area is 2.

Gas injection station (example with calculation of ventilation plant)

Consider the presence of two injection stations at the compressor of the air conditioner. The air conditioner is being charged within the production area. There will then be emissions: each time the charging nozzle is removed, a small quantity of refrigerant will vaporise and spread in the atmosphere of the production area. Over time, with repeated charging, it is possible that a higher concentration of gas could accumulate. To avoid that this occurs, a ventilation system must be installed, in particular an air suction plant that will guarantee a suitable level of ventilation:

- Ventilation High (HV)
- Availability Good

In order to obtain these features of a ventilation plant some hypothesis must be made:

- approximately 0.5 gram of refrigerant (R600a) is released at each injection occasion
- the environment temperature in the department is 20°C
- approximately 200 injections per operation hour

This gives us a release of 100 gram/h gas in liquid phase; converting into volume of vapour through the use of the vapour density at standard atmospheric pressure where 1 m³ of vapour equals 2.45 kg gives us:

41 litres of R600a vapour will make the following volume of air explosive (assuming a LEL of 1.8% in the surrounding air volume):

$$41/0.018 = 2,278 \text{ litres or } 2.3 \text{ m}^3.$$

If an atmosphere of less than 0.5% LEL should be maintained, an aspiration capacity of at least:

$$2,278/0.5\% \text{ (equals to approx. } 500 \text{ m}^3/\text{h) is needed.}$$

To make the reasoning complete, the possibility of degassing the lines has to be considered as well. The probability of leakage from one of the compressors and the area obstructions which could influence a free flow have to be taken into account. A factor 5 will provide in most cases a correct capacity, so a final capacity of air suction will be:

$$2,500 \text{ m}^3/\text{h}$$

In order to maintain “Good availability” (meaning a guarantee that the ventilation is always present), two fans should be installed in the ventilation systems: One in use under normal conditions whilst the other acts as a backup. In case of damage of one fan the other will automatically start. However, it should be noted that the normal operation of both should be periodically alternated to ensure both are in good working order.

Conclusion:

- The emissions are grade 0
- Ventilation grade is high
- Availability is good

Result: The area is classified Zone 0 NE.

In this case it can be checked that there is a continuous source of emission in the department, but the ATEX area can be reduced to negligible size.

Note that the same principle is applied for all refrigerants which are classified flammable, the strength of explosion power, level when they achieve the LEL, flashpoint etc., all do not matter.

The principle is to limit/reduce the ES to a minimum.

Please note that some refrigerant charging machines are equipped with special injection guns which after charging clear the gun of residual refrigerant. These guns do not have a structural release after every charging and the classification of the charging point is different.

Figure 18: Example – charging gun Galileo TP (picture courtesy of Galileo TP)



Testing station and test cabins

The ES consist of valves and containers of the refrigerating system.

Emissions will occur less frequently and for short periods of time (the equipment has already been tested). Therefore the ES are not predicted during normal operation thus considered second grade ES.

- Second grade ES
- Medium ventilation
- Ventilation availability good

gives: Hazardous area 2.

Gas detectors are installed to signal the presence of gas and to activate the ventilation plant in high speed.

The gas detector installation method will be described in chapter 3.5. However, it is important to consider that the quantity of air withdrawn from an area or container must be restored with air from the outside, and this air must not be contaminated.

3.5 Gas detectors

The probability of the formation of explosive atmosphere above the minimum concentration is not uniform. It is most likely that the highest concentrations are within the close proximity of the ES, diluting further away from the ES. It is however possible to reach greater quantities at a distance from the ES where the refrigerant may accumulate, such as underground passages, shafts, etc.

The accumulation and dilution of gas are determined by two factors:

- Specific weight
- Ventilation

The specific weight of a gas¹⁷ or vapour can be schematised as follows:

Specific weight lower than 0.9:

- Upwards diffusion of vapour
- Possible accumulation underneath the roof

Specific weight between 0.9 and 1.1:

- Uniform diffusion of vapour with lower intensity moving away from the ES

Specific weight higher than 1.1:

- Downward diffusion of vapour
- Possible accumulation at floor level (underground passage, shaft, etc.)

The ventilation and the movement of the air volume generate a dilution more or less extended in function of the above parameters.

In the previous paragraphs, the use of ventilation to dilute the explosive atmosphere has been evaluated. In the following, important safety components for the use of flammable substance are introduced: Explosive Atmosphere Detectors.

¹⁷ Specific weight is referring to air considered as 1

Explosive Atmosphere Detector - Type of detector

In the industrial sector the following detectors are used most frequently:

- Catalytic combustion
- Infrared

The function of both types is to detect small percentages of flammable gas within the atmosphere of the space where the flammable substance is used, then the processing of the signal and the management of the signals according to the safety procedures are described as follows:

Usually the detectors are calibrated to detect and process two levels of concentration: **15% and 30% of LEL.**

Note that suitable sensors should be used and catalytic type of sensors cannot be used in areas where halogenated refrigerants are used (e.g. R134a, R22) as they can interfere with the measurement.

Installation and function

The gas detectors must be positioned in order to control the area where explosive atmospheres may occur. The function of the detection system is to try to anticipate the formation of an explosive atmosphere or promptly signal a sudden formation in case of production machinery damage.

The safety of the area should be controlled by the ventilation system, controlling it in such a way that there will not be any flammable substances present and allowing the detectors to control that accumulation of dense gas does not occur.

The detectors are encapsulated in Ex-rated enclosures¹⁸ and connected to a processor unit. Incoming signals are processed in a logical manner, for example:

- Detector signalling LEL 15% - **pre-alarm**
- Detector signalling LEL 30% - **alarm**
- Pre-alarm commands: 2nd ventilator start (reserve ventilator)
 - Yellow light switched on
 - Siren sound switched on

¹⁸ For further information see Chapter 4

- Alarm commands: Maintaining function of 2nd ventilator
 - red light switched on
 - Maintaining siren sound
 - Blocking the distribution of product
 - Blocking the electrical power

A simple rule to keep in mind when positioning the detectors:

- If vapour is lighter than air, the detector must be installed in the upper part of the room.
- If vapour is heavier than air, the detector must be installed at floor level.
- If vapour weight is between 0.9 and 1, detectors must be distributed both in upper part and floor level.

For each ES at least two detectors must be installed. In each point of potential accumulation it is possible to install only one detector (except when it is necessary for surveillance of underground passage or shaft).

In chapter 5, 6, 7 the ventilation system installation and explosive atmosphere detection system installation is demonstrated with practical examples.

4. ELECTRIC PLANTS: ELECTROSTATIC CHARGES AND ATMOSPHERIC DISCHARGES

4.1 Introduction

All components of an electric system present a potential hazard if they produce or exceed the ignition temperature¹⁹ of flammable material, either during normal operation or due to malfunction.

During normal operation the following components can be hazardous:

- Resistance heaters
- Incandescence lamps
- Electrical motors
- Electrical switches
- Poorly installed electrical wirings

During normal operation and in case of malfunction, the following components may be hazardous:

- Cables
- Junction box
- Batteries

Experts always consider a certain state-of-the-art depending on the standards they are used to. Proper electrical installation has to be done according to the standards in place. Especially improper wiring and connections is a returning hazard (for example duct tape connected wires, loose wires not properly placed in channels, open electrical cabinets, etc. make each area hazardous even without the presence of flammable substances).

The initiation of an explosion may be caused by sparks or overheating. To avoid initiation of an explosion the following precautions must be provided:

¹⁹ Referring to the definition in chapter 2.4

1. Explosion limitation by use of an enclosure and appropriate electrical cabinets.
2. Avoid contact between hot surfaces and the surrounding atmosphere by the use of solid barriers, liquid or gas, between the components (example: electric power panel with pressurised nitrogen), and separation of the atmosphere inside the box/shield/container from the outside atmosphere of the hazardous area.
3. Lower the energy level of the system so that there will not be enough energy to initiate an explosion. This is called intrinsically safe²⁰ (e.g. EN 60079-11).

A potential hazard may also be:

- Electrostatic discharge
- Over-currents generated by direct or indirect atmospheric discharges

The safety requirements for electric power systems in explosion hazard areas are established by the EN 60079-14 Standard.

Before describing the methods of protection, certain definitions indicated in the following must first be analysed.

4.2 Construction temperature classification

The initiation of an explosion may be caused by the temperature of the external or internal parts of a component, e.g. a lamp cover or junction box, or bearings inside a motor.

To avoid this hazard, every apparatus installed in a zoned area must be classified by the maximum temperature that it may reach. Such temperature, measured during worst conditions, must not exceed the auto ignition temperature of the hazardous substance (typically more than 100K below the auto-ignition temperature). For example, if a cover of a resistance reaches 280°C it cannot be used in an explosive atmosphere with hydrogen due to the fact that the auto-ignition temperature of hydrogen is lower. Thus the components are classified by temperature as shown in Table 4.

²⁰ Only for electronic signal circuits and not for electric power circuits

Table 4: Equipment temperature classification

Maximum surface temperature in °C:	450	300	200	135	100	85
Temperature class:	T1	T2	T3	T4	T5	T6

The Standard does not indicate a temperature class for cables but indicates measures to adapt during installation. All cables in hazardous areas must be protected from overload.

4.3 Protection methods allowed by ATEX directive

The EN 60079-15 Standard introduces **Ex-n**, a way of protection for electrical apparatus. The **Ex-n** method of protection is based on prevention measures and is divided into two main categories:

Ex-nA applicable on equipment, which under normal conditions does not produce sparks

Ex-nC applicable on equipment, which under normal conditions produces sparks

Examples of **Ex-nA** equipment are:

- Junction boxes
- Fuse boxes
- Illumination apparatus

4.4 Materials and constructions in conformity with ATEX

All constructions for potentially explosive atmospheres must be distinguished from others by an obligatory system of labelling. The system identifies the components suitability for installation in hazardous area.

Furthermore, the construction material must be accompanied by a detailed documentation, which certifies the conformity with the standard. These documents are issued by:

- The constructor of the parts
- Certifying organisation, such as at European level the TÜV

The labelling which demonstrates conformity with the ATEX directive is:

CE marking

- Demonstrates the conformity to the directive for all the features including the ones not specified for the protection against explosions.

Ex marking

- Identifies the suitability for installation in explosive atmospheres.

Letters d, p, o...IP

These indicate the method of protection. The letters represent:

- d - explosion proof construction
- p - internal over pressure construction
- o - construction for use in oil
- q - construction underneath sand
- m - construction for encapsulation
- i - intrinsic safe construction
- d - increased safety construction
- n - simplified construction
- IP - (xx) protection through sealed casing

Roman numbers I, II

Identify field of employment in two cases only:

- Mining group I
- Other cases group II (application not in mines always use group II)

Apparatus category

The categories are indicated by numbers:

1. Very high level protection
2. High level protection
3. Normal level protection

The relevant schedules are summarised in Table 5.

Table 5: Summary apparatus category

Category	Level of protection	Performance	Enclosed documentation	Zone
1	Very high	Double barrier	- CE marking - Conformity certificate - Notified body certificate	0, 1, 2
2	High	Single safe barrier	- CE marking - Conformity certificate - Notified body certificate	1, 2
3	Normal	Single barrier	- CE marking - Conformity certificate	Non-hazardous

Letters G and D

These indicate the treated combustible substance: G= gas and D=dust.

T1...T6

These indicate the temperature class defined in the previous paragraph correlated with the maximum temperature which the casings/covers and/or hot spots may reach in hazardous areas.

Identification plate

Figure 19 illustrates an example of a safety marking plate typically attached to a gas detector.

Figure 19: Example of a plate attached to a gas detector



4.5 Gas classification sub-groups

Gases can also be classified by the minimum dimension of the opening of a case through which an explosion may spread and by the energy needed to ignite.

These features regard methods of protection **Ex-d and Ex-i**.

The group II constructions are classified as follows:

- II A:** Gas of vapour allowing interspaces more than 0.9 mm with a relation between their ignition current and the ignition current of methane more than 0.8²¹
- II B:** Gas or vapour allowing interspaces between 0.9 and 0.5 mm with a relation between their ignition and the ignition current of methane between 0.8 and 0.45
- II C:** Gas and vapour allowing interspaces less than 0.5 mm and with a relation between ignition and the ignition current of methane lower than 0.45.

The Group **II C** constructions are suitable for group **A and B** gases, while group **II B** constructions are suitable *also* for group **A gases**.

Generally, the gas containers used in the blowing agent field must be at least a group **II B T5**.

²¹ Ignition current of methane as reference

4.6 Qualification of material for installation in various areas

It is now easy to connect the various methods of protection to the selected area. The following schedule demonstrates the qualifications:

First, the planning of the plant needs to be considered:

- a. The zone “0” areas should always be avoided in installations where personnel presence is required.
- b. The zone “0” areas can be found only in closed containers separated from the surrounding atmosphere.
- c. In zone ”0” areas only fail-safe constructions are allowed.
- d. Category 2 constructions are allowed for ATEX areas and include practically all protection methods.
- e. The “n” protection method is applicable for Zone 2, i.e. simplified protection.

Table 6 demonstrates the EX constructions suitable for areas with gas presence.

Table 6: Zones with corresponding construction standards

Zone	Explosive mixture presence	Type of construction allowed	Protection method
1	Continuous	II 1 G	ia
2	Occasional	II 2 G	ia, d, e, ib, m, o, q, p,
3	Only in case of damage	II 3 G	ia, d, e, ib, m, o, q, p, n

The protection methods **ia** and **ib** refer to as being intrinsically safe. The principle of protection is based on guaranteeing that the energy released is always inferior to the minimum energy for igniting a flammable gas in a zoned area. This protection method can only be used for low voltage (signals) electrical equipment. Please note that an electrical motor or high voltage equipment when not suitable for an ATEX area will always have sufficient energy to ignite a gas.

The systems are subdivided into two main categories:

- category ia
- category ib

and are used in the following ATEX zones:

- category ia – ATEX Zone 0
- category ib – ATEX Zone 1

4.7 Atmospheric discharge protection (lightning)

Introduction

Protection against atmospheric discharge (lightning) is described in the **EN 62305 Standard**.

The atmospheric discharges have four types of impact:

1. Facility directly hit by lightning
2. Facility indirectly hit by lightning (e.g. ground near the structure gets hit by lightning)
3. Incoming lines directly hit by lightning
4. Incoming lines indirectly hit by lightning

For a plant with storage and handling of flammable material it is always necessary to perform an evaluation of the risk of atmospheric discharge.

Basic principles for protection against atmospheric discharge include:

- Protection of facility, plants and equipment
- Protection of personnel in the facility
- Protection of incoming telecommunication lines
- Protection of electric power supply and metal piping

Damage due to lightning

Lightning can cause three types of damage:

- Damage to living beings
- Damage to material due to fire, explosion, mechanical failure, toxic substance leakage and **ignition of explosive atmosphere** in zoned areas.
- Electrical apparatus failure due to overcharge.

Protection against lightning

Direct hit: The facility must be protected by an external lightning protection system (LPS), usually a Faraday cage.

Indirect hit: All openings in the “cage” must be electrically connected directly to the “cage” by source protective device (SPD).

An expert evaluation of lightning impact on the facility and/or flammable storage area must always be performed.

General protection methods include:

- Installing a “cage” LPS on classified buildings
- Grounding of system for all metallic objects in contact with the protected area
- Applying tension dischargers to all conductors in contact with the protected area or zoned area

The protection methods must also be applied on underground tanks.

4.8 Grounding system – electrostatic discharge

All metallic objects in the zoned area must be ground connected and the grounding plant must be connected to the dispersion plant. There are some complicated calculations for the planning of a dispersion plant, given the resistivity of the ground. In general, experience is relied upon, considering the following:

- a. An underground copper wire of 50 mm² without cover at 1 m depth, running alongside the outer wall of the facility guarantees efficient dispersion.
- b. The electrical resistance measures will guarantee safety.
- c. Steel or copper spikes in the ground will contribute to the ground resistance when the copper wire does not provide a sufficiently low resistance.

According to general usage, the earth resistance in an ATEX environment should be less than 1 Ohm. For lightning protection, an earth resistance of considerably less than 10 Ohm is needed. These values are normally given by the national laws for erection of electrical/ATEX equipment.

4.9 Electrostatic charge

The accumulating electrostatic charges may provoke spark or sufficient energy to ignite an explosive atmosphere. It is therefore always necessary to avoid any accumulation of electrostatic charge in an ATEX area²². The electrostatic charge originates from being in contact between two bodies of different kind. An electron transfer takes place during the contact and one body will have an excess negative charge, while the other will have an excess positive charge. When the two bodies are separated, an electric charge takes place.

To avoid an electrostatic charge, besides avoiding synthetic material, the best method is to ground-connect and make the objects, conducting parts and the conveyors of flammable substances equipotential. It is not necessary to ground-connect the metal objects that are not exposed to electrostatic charge, such as window and door frames.

Generally, the plant structures are mechanically ground-connected through bolts or welding, which are good methods for the electrical continuity. The bolt (or similar) must have a resistance less than $1 \cdot 10^6$ Ohm for a secure ground-connection.

The equipment and machinery installed are already protected and certified by the constructor and certification organization. However, it is advisable to adapt and follow the most common precautions, as listed below:

- DO NOT use non-conductive pipes and containers in the presence of high resistance flammable liquids.
- In zone "0" areas no high-resistance containers are allowed. Only very small containers for sampling.
- Avoid any rapid filling of tanks, which occurs when loading by gravity of underground tanks.
- Avoid dragging air or gas into liquid.
- Reduce to a minimum the mixing revolutions.
- Do not use vapour in tank cleaning operations.
- Reduce the power and pressure of the cleaning equipment when cleaning the tanks.

Before proceeding to the loading of a liquid from tank-truck, an equipotential connection between the truck and the vessel must be performed.

²² Note that many flammable substances accumulate electric charges.

NOTE: The closing of the circuit must be performed according to ATEX. Furthermore, the connecting pliers **must** have isolated handles to avoid discharges.

- Transfer from barrel to container by a mobile pump may cause sparks between pump and barrel especially when the pump is inserted. Before transfer it is therefore necessary to ground-connect pump-barrel-container.
- Thorough evaluation of the belt-conveyors, ventilator belts and engine belts installed in the ATEX area must be performed.
- Personnel must be equipped with anti-static garment. Shoes must have ground-resistance of less than 105 Ohm.
- It may be useful to proceed to deionisation of the environment. The installed machinery must be ATEX certified and ground-connected.
- Body and flexible tube of the pressurised fire-extinguishers installed in ATEX areas must be ground-connected.

5 STORAGE PLANT AND REFRIGERANT DISTRIBUTION

5.1 Storage systems

The refrigerant is stored in metal containers, pressurised or in balance with the atmospheric pressure. The pressurised containers contain refrigerant in liquid phase.

The refrigerants normally used in the production cycle are;

- a. HC R600a²³
- b. HC R290 (propane)
- c. HC R1270
- d. HFC R161
- e. HFC R32
- f. HFC R1234 yf²⁴

These refrigerants are liquefied gases under pressure. If the refrigerant in the container would be in contact with the surrounding atmosphere, it would change phase to vapour more or less rapidly. The refrigerants which have a boiling point equal or higher than ambient temperature, in contrary to the above mentioned, are liquids stored in containers without positive pressure. If the refrigerants would be in contact with the surrounding atmosphere they would remain liquid for a long period of time.

As a function of the refrigerant in use, there are two different types of storage:

- Pressurised tank storage
- **Non**-pressurised tank storage (atmospheric pressure)

Tanks can be divided into two types:

1. Mobile
2. Fixed

²³ Isobutane is used in refrigerators

²⁴ This may be used as a new refrigerant for automobile air conditioners

5.2 Pressurised tanks

The pressurised tanks and pressurised plants are subjects to **ATEX** and also to the European directive **PED 97/23/CE (Pressure Equipment Directive)**. Mobile containers or cylinders are subject to the European directive **T-PED (99/36/CE)**. The directive indicates methods for construction and installation of pressure equipment. This document does not examine the PED directive. However, it is important to know that pressurised tanks and plants must be ATEX and PED (CE) certified.

Cylinders for pressurised plants consist of tanks of various sizes from 10 kg to 800 kg transported by truck and stored in appropriate areas.

5.3 Construction method for storage areas

5.3.1 Mobile cylinders under pressure

Basic rules: the storage room for the pressurised and flammable refrigerant tanks must be positioned outside of the production facility. The storage room must be in contact with the open air and equipped with adequate ventilation. Furthermore the storage room must be positioned at a secure distance (minimum 7.5 m) from:

- Openings and air intake, thus to avoid the spreading of gas in case of damage
- Heating provisions
- Local compressors
- Electric generators
- Transformation cabinets
- Water drainage, grounding shaft, cable shafts and other passages

In Europe, when the quantity of HC's is less than 15 kg, the storage can be inside the production department and the bottle is placed inside a ventilated box.

It must be kept in mind that the storage room is (likely to be) Zone 2 which means emission of hazardous substance only in case of damage or failure (see chapter 3.4).

The storage room must be positioned in the open air with no other structure or building above the roof.

The construction material for the storage room may be:

- Concrete
- Brick-work
- Sandwich panels (metal sheets with mineral wool in-between, class “0” panel)

The floor must be of concrete and/or antistatic material.

The roof should be constructed in light material provided with breaking points.

The storage room should **not** be constructed in metal sheets (with no insulation). In warm climates and during summer the pressure inside the tanks will rise with the temperature.

The deposit/storage room can have two types of ventilation:

- a. Natural
- b. Artificial ventilation: preferred due to motives explained further on.

If natural ventilation is selected then the following must be provided for:

1. Openings in the upper and the lower parts of the room. Openings protected by metal grids.
2. Openings must be of grade A, without closure.

Plants and systems

Inside the storage room there should be two tanks installed, one in service and one in reserve. Tanks of small dimensions must be positioned alongside the walls fastened with hooks to prevent them from falling down.

If larger tanks are used (300-800 kg) they must be positioned on supporting structures²⁵. The supporting structures should be slightly inclined towards the withdrawal point, thus to facilitate the emptying of the tank.

Furthermore, the bottom of the tank must **not** point towards hazardous areas in general and hazardous area outside the storage room in particular²⁶.

A system to elevate and move the tanks must be provided (for example block-and-tackle a small manually operated lift ATEX) to move the tanks heavier than 20 kg (use of fork-lift must be avoided²⁷).

²⁵ Tanks equipped with two opposite attachments. Refrigerant can always be withdrawn from any position of the tank.

²⁶ The bottom of a tank cylinder is always the weakest component, in case of fire it will be the first part to collapse.

²⁷ If fork-lift is used it must be ATEX certified.

The tanks are connected to the production plant by means of a collector system with intake for the refrigerant. The construction must be executed as follows:

1. Construction of a system with nominal pressure of at least 1.5 times the pressure indicated on the mobile tank plate.
2. Installation of a maximum pressure switch and a minimum pressure switch, both connected to sound and visual alarm.
3. Installation of a safety valve (appropriate dimensions) with valve exhaustion positioned on the outside of the building in a safe place (non-hazardous place).
4. Installation of a ball-valve at each attachment.
5. Installation of a flanged flexible attachment. **Note: Even if technical standards allow the use of threaded junctions narrower than one inch, it is always better to install flanged junctions.**

In general, industrial plants using tanks are not equipped with thrust pumps. The product flows naturally through the pipeline towards the injection plant fed by the suction pump of the injection plant. In case of longer distance thrust pumps are used which require the same pressure ratings.

The following systems are needed to complete the storage plant for pressurised mobile tanks:

1. Ventilation system
2. Lighting (illumination) system
3. Gas detector system
4. Tank cooling system
5. Grounding system for the protection against electrostatic discharge

Ventilation System²⁸

The ventilation system must be constructed in the following way:

1. Installation of four air intakes²⁹ of 100 mm on the side walls
2. Installation of two air intakes of 150 mm near each refrigerant collector attachment. The intakes must be equipped by a flexible tube in order to move and be positioned at the attachment during the degassing phase of the attachment. Degassing must be done each time tanks are exchanged.
3. Connection of all air intakes to a double-ventilator positioned outside the facility

²⁸ Assumed storage room area is 15 m² (5x3 m)

²⁹ All intakes must be provided with air flow regulating system

4. Installation of a gas exhaustion chimney of at least 1.5 m above roof-level (referring to the highest roof-level of the tallest building around the storage room area)
5. Install:
 - a. Flow-meter controlling the efficiency of the ventilation
 - b. Switch for manual operation of both ventilators (fans)

The entire system must be constructed in metal sheet, the sheets may be galvanized or stainless. If galvanization is used, all components must be ground-connected by a 2.5 mm² cable for tubes, and minimum 4 mm for other machines (the colour of the cable must be green and yellow). In case the ventilation ducts are sealed with isolating junctions, they must be ground connected with each other to warrant grounding continuity. When a belt driven fan is used the belt must be antistatic in conformity with ISO 1813. Grounding continuity of the complete system should be less than 10 Ohm to earth.

The ventilation system must function as follows:

Normal function of ventilation:

1. One fan must always be running.
2. The ventilation system must be connected to the gas detection system described in the next paragraph.
3. If the gas detectors register an explosive atmosphere of 15% of LEL, a second fan is activated and alarm signalled.³⁰
4. If the first ventilator is not activated the second (reserve) will be automatically activated and alarm is signalled.
5. The additional system must be manually activated during exchange of the tanks. A very small quantity of gas always remains inside the tubes. It is well known that a few drops are enough to create an explosive atmosphere inside the storage room.
6. Every ventilator (fan) must have the following features:
 - Type: Backward curved blade
 - Capacity: 3000 Nm³/h
 - Suction power: 100 mm H₂O

The system is (of course) subject to the ATEX standard in Zone “2”.

Ventilators with double speed are also allowed, evacuation power of 3000 to 6000, but also in this case redundant ventilators are required.

³⁰ The entire plant must be monitored by a control panel positioned in an area where personnel are always present.

Gas detection system³¹

Two gas detectors must be installed (catalytic or infrared) at floor-level. The detectors must be connected to the main alarm system.

Electric- and connective plants

All electric plants must be constructed according to appropriate (e.g. EX-d³²) methods, e.g. covers/cases of group II category 2G with temperature class minimum T5. It is advisable to use Ex-d method of protection which guarantees an important mechanical protection against impact/blow and resistance against disengagement.

The features of a system operating by EX-d method:

- Clamp cases and apparatus issuing sparks must be explosion proof.
- Cable exit/entry from the boxes must be block junction. Electrical ducts galvanized without welding, tube mechanical blow/impact resistant.

Lighting plant (illumination): An explosion proof lighting plant with two ceiling lights 1×36 Watt in e.g. Ex-d performance. One equipped with emergency lamp.

Tank cooling plant: A cooling plant with aerosol sprinklers should be provided.

Grounding plant: The installed equipment must be ground-connected and a box of antistatic tools (bronze wrenches and hammer) should be provided for.

5.3.2 Fixed pressurised tanks

The tanks are generally steel tanks with capacity between 1000 and 5000 litres. The tank in this case is positioned on a concrete or steel support, preferably reinforced concrete to avoid structural collapse in case of fire. Generally the tank is installed on the ground. In some cases, with lack of safety distance, they may be covered by soil. If the tank is installed in the open air, insulation must be provided for in order to avoid overpressure due to sun heating.

In any case, the tank must be:

- a. Positioned outside the facility, in area without covering structures
- b. Distant from hazardous operations and ignition sources

³¹ If gases are equal or lighter than air the number of ventilators must be doubled.

³² In this area also an Ex-n method would be sufficient according to the EN 50021 standard.

- c. Protected against blow/impact from vehicles in motion
- d. Maintain safety distances

The tanks in this case present sources of hazard and must therefore be considered as hazardous areas.

The determination of the distances to be respected on the basis of definition of hazardous areas varies from country to country. It is however good practice to follow the listed indications:

- Distance from the border of the establishment: 7.5 m
- Distance between the positioning of tank and truck: 3.0 m
- Distance between flammable and non-flammable tanks 15 m³³
- Distance between hazardous elements: 7.0 m
- Distance to railway, schools, etc.: 15 m

These distances are indicative and serve the purpose of supplying maximum distances. The distances should be evaluated from case to case with reference to the standards and regulations of the country where the plant will be constructed. The tanks must be constructed with reference to the PED standard for “pressurised tanks”.

Figure 20: A typical pressurised tank

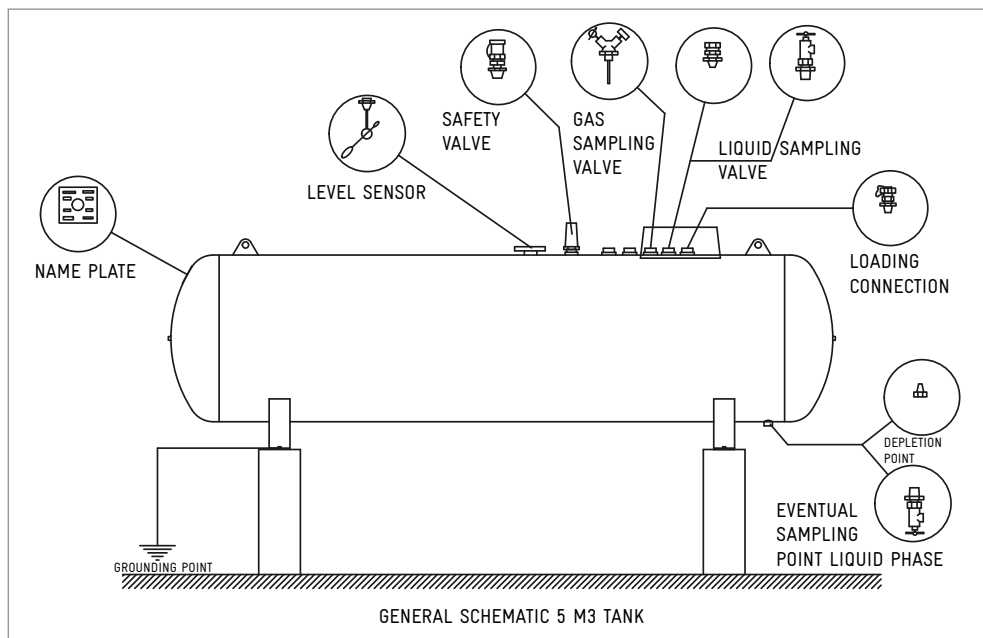

³³ There may be an introduction of gas into the second tank through the balance valve, emitted from the safety valve of the first tank.

5.3.3 Mobile containers at atmospheric pressure

The construction of the storage room is the same as in the previous chapter. A tube must be installed in the storage room with the volume corresponding to half the volume of the stored liquid.

The ventilation of the storage room cannot be natural. A ventilation system must be provided. Depending on type of withdrawal, a Zone 1 can be created.

For example: if the refrigerant is withdrawn by a pump with inserted tube, the opening of the cistern becomes a continuous emission source. It is therefore important to install a ventilation system positioned in the proximity of the emission to reduce the source to **Zone 1 NE**.

A pumping station for the feeding of the refrigerant to the charging machine may be installed. The pumps can be operated:

- Electrically. In this case the system must be of the type described in the previous paragraph.
- Pneumatically. In this case the system operates by compressed air.

In addition to the previously described equipment, the storage must be provided with nitrogen gas for the purpose of:

1. Inertisation of the refrigerant tanks
2. Prevent flushing in case of maintenance

A nitrogen system is constructed as follows:

1. Nitrogen bottle of 50 litre with pressure of 200 bar
2. First step reducer from 200 to 3 bar
3. Second step reducer with regulator from 3 to 0.2 bar
4. System reducing the flow. Avoiding that the entire pressure flows into the tank to be inertised in case of damage, overpressure can lead to failure of the tank.
5. Ball valve and distribution piping
6. For greater quantities of tanks it is possible to install a pack of nitrogen bottles to obtain more autonomy. The bottle pack is self storing but the single bottle must be stored with the precautions described in the previous paragraphs.

6 PRODUCTION AREA AND TEST CHAMBERS

Hereafter a sample production line is presented (Figure 21). This sample layout is for reference only. As mentioned in the introduction, the basis for production is a certified air conditioner which satisfies the required refrigeration standards.

The production line which rotates anti-clockwise is shown as a sample production line layout in Figure 21. The purpose of this layout is to explain in detail the safety aspects of the different areas of activities. Before going into the detail of these areas, first comes a short description of the production line:

1. Assembly area – assembly of mainly the outdoor unit, placement of compressor
2. Brazing area – an area with a suction hood as with brazing, acetylene is used which is highly flammable. The outdoor unit is brazed and other brazing activities are performed. Note that the brazing area has to have all the safety relevant equipment according to the local regulations!
3. Quality test station – verification of the brazing and the assembly, mainly mechanical tests like e.g. tightness and eventual helium leakage testing
4. Vacuum purging test station – before the unit is charged with refrigerant a pre-vacuum is created and it is advisable to also perform a vacuum test (verification that there is no leakage).
5. Gas sensors and ventilation safety cabinet
6. Refrigerant pipeline and safety valve
7. Refrigerant bottles storage room – ventilated
 - 7a. Refrigerant injection pump
 - 7b. Ventilation system
8. Refrigerant charging and ultrasonic welding room – in this area refrigerant is charged for the first time. After the charging, the charging point is sealed mechanically or by means of ultrasonic welding.
 - 8a. Refrigerant charging equipment
 - 8b. Ventilation
9. Leakage test station no. 1 – the unit is checked for leakage by means of calibrated sniffers dedicated to the refrigerant in use.
10. Assembly area – final assembly of the unit
11. Electrical test room - the electrical part of the unit is tested
12. Functional test room – the units are powered on and all the relevant functional aspects are verified and eventual performance characteristics measured
13. Leakage test station no. 2 – additional leakage test

Figure 21: Production department layout

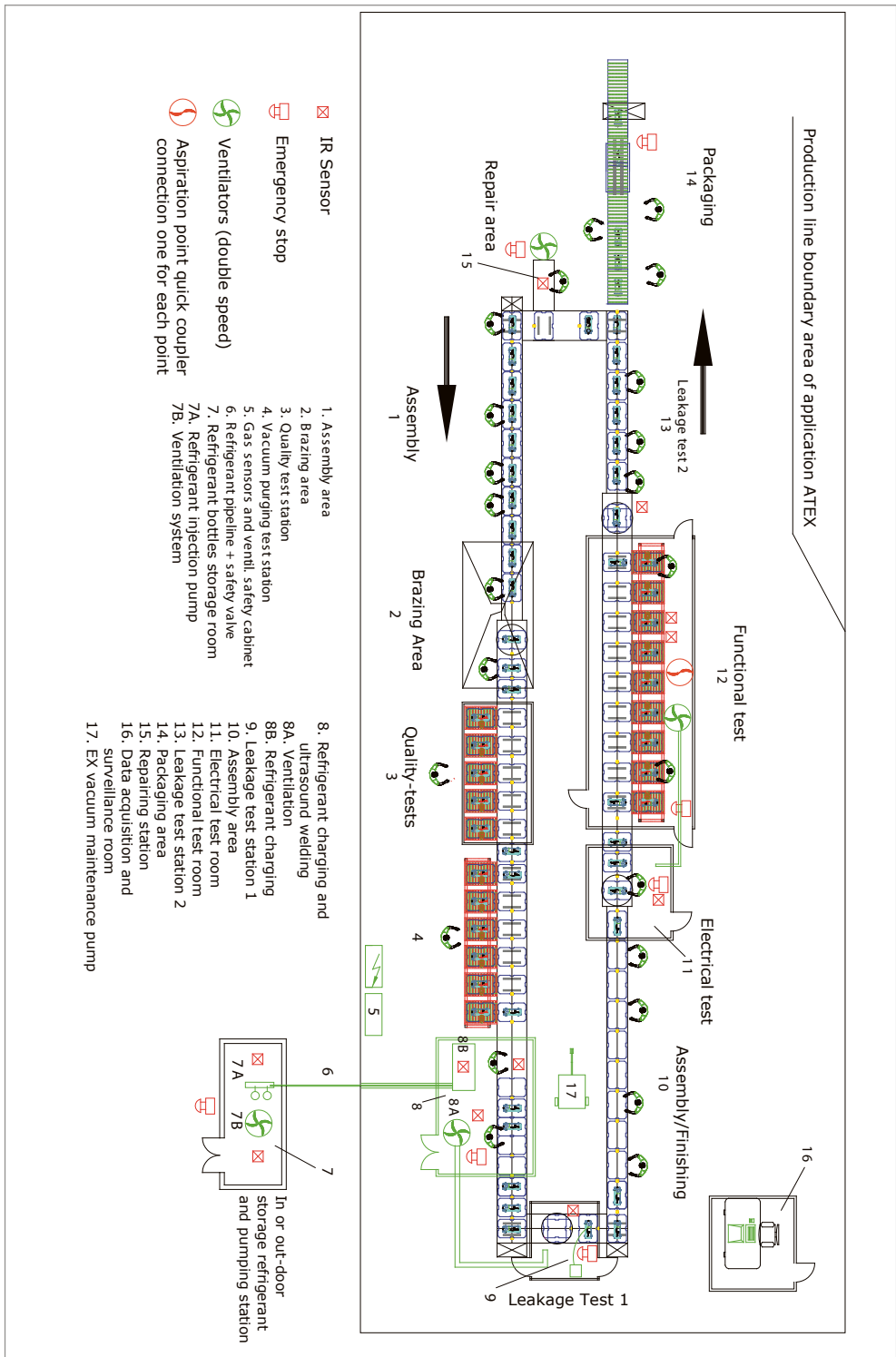

14. Packaging area
15. Repairing station – separate area where units which did not pass the tests are being repaired
16. Data acquisition and surveillance room

Important note: Within the repair area, any unit which malfunctions needs to be discharged of the refrigerant before displacement. Malfunction of a unit can only be verified when these are under test but it is not possible to send this unit to a repair area with refrigerant inside. There are several reasons for that, mainly that transporting leaking units to areas which are not suitable for handling flammable refrigerants should be avoided or that personnel are not aware of the required procedures. **For this reason mobile or several fixed EX vacuum pumps must be placed around the production line for emptying completely the unit by qualified personnel. Depending on the amount of refrigerant inside the equipment and the evacuation capability the appropriate zoning has to be considered.**

6.1 Production line boundary area of application

ATEX

All around the production line shown in the layout, Figure 21, by the “rectangular box”, the safety concept must be applied. Although not all areas are subject to ATEX as there won't be any emissions, still electrical safety measures need to be applied. In case of 2nd level alarm, red lamp and sirens, this whole area will be disconnected electrically by the safety control system. This is application of a worst case scenario but, on the other hand, from production point of view the safest. The safety illumination system will of course remain in function.

The area marked by the rectangular box needs to be marked and all safety related organisational measures applied in order to avoid the common error of maintenance and repair jobs which could have extension in areas which are subject to ATEX requirements. Figure 22 shows the sign to be installed in the hazardous areas.

Figure 22: EX symbol indicating ATEX area

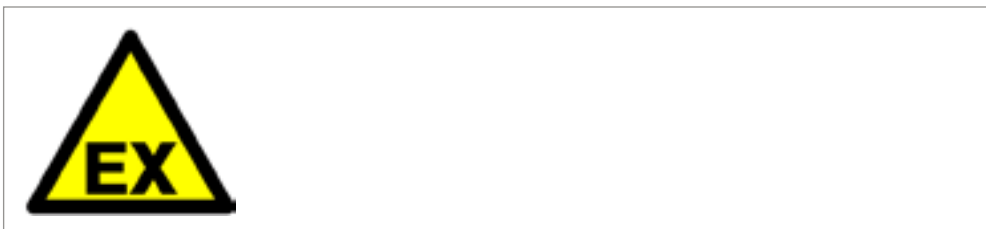

Note 1: Ventilation ducts often have long stretches inside the factory which are far away from the production area. As they contain air aspirated from areas where flammable refrigerants are used, the inside is Zone 2. Therefore, like with the marking of all other factory piping, these ducts need to be marked appropriately including the exhaust on e.g. the roof which is seldom inspected.

Note 2: All the equipment in the area must be grounded and the floors verified for antistatic charging. This grounding includes also the ventilation ducts and all other piping entering the area.

6.2 Production department - refrigerant charging³⁴

The refrigerant is injected into the refrigerant compressor by means of the refrigerant charging machine (point no. 8a in Figure 21) in position 2. Whereby the following procedure is executed:

1. The air conditioning apparatus arrives from the pre-vacuum station on the conveyor
2. The refrigerant gas injection gun is connected and the vacuum level is checked
3. When the vacuum is achieved the refrigerant is injected into the circuit
4. The gas injection gun is disconnected
5. The loading tube is closed by ultrasound or mechanical closure or the loading tube is welded
6. The air conditioning apparatus moves on to the quality control/leakage test area

As described in Chapter 3, the hazardous area is identified by:

- a. Emission source grade 0: liquid gas remaining inside the tube and inside the Hansen quick coupler: The quantity is estimated to 0.5 gram per injection³⁵.
- b. Gas drop expands enormously (**229 times for R600a isobutane**)
- c. A Zone 0 forms around the injection point

NOTE: All values given in this chapter are based on the assumptions done earlier in this document. The use of different gases, volumes etc. can lead to different values and have to be individually calculated.

³⁴ No. 8 in Figure 21

³⁵ The gas quantity is hypothetical. For each installation the diameter of the tube and the quantity of refrigerant must be verified.

Refrigerant charging department – Ventilation (8b in Figure 21)

Here, Zone 0 should be limited to a **Zone 0 NE**. To achieve this, the air volume which should be displaced has to be defined.

In the proximity of the charging gun/nozzle there must be an adequate aspiration, defined as follows:

1. Capacity approx. 2500 m³/h
2. Aspiration power (minimum) 120 mmH₂

In this way we will obtain aspiration with the capacity to eliminate as quickly as possible the gas cloud generated by the small drop before it expands. Note that modern refrigerant charging guns have a build-in aspiration system. Nevertheless the Hansen connector and the point of quenching the pipe for closing the charging pipe contain also a volume of refrigerant.

The ventilation system must be constructed as follows:

- Install an extendable arm with a diameter of 160 mm in order to position the aspiration nozzle as close as possible to the injection gun when charging or removing the Hansen connector depending on if the injection gun has a build-in evacuation system. The extendable arm has the advantage of being adaptable to the point which needs to be evacuated. Fixed ducting is also possible but needs to be well dimensioned.
- Install a fixed duct underneath the belt conveyor.
- Install a flexible tube of small diameter attached to the main flexible tube, which connects the injection gun to the machine (not required for machines with build-in gun aspiration system).
- Installation of a fan with features indicated previously in point 1 and 2 dedicated to this particular plant.

It is recommended also to install a fixed duct behind the charging machine, opposite to the fixed duct underneath the conveyor.

NOTE: If the injection points are more than one, an aspiration plant must be provided for each injection point.

The capacity for each point is suggested to be as follows:

1. 1500 m³/h of the extendable arm
2. 500 m³/h of the duct underneath conveyor
3. 500 m³/h of the small flexible tube attached to the injection gun flexible

The plant should correspond to the general criteria for a storage area listed in Chapter 5:

- An air intake must be connected to a double fan positioned outside the facility.
- A gas exhaustion chimney min. 1.5 m high reaching above the highest roof of the buildings that surround the storage area.
- The ventilation system must have an airflow meter controlling the efficiency of the ventilation.

The entire system must be constructed in metal sheet; the sheets may be galvanized or stainless. All components must be ground-connected by a min. 2.5 mm² cable for electrostatic discharge.

The functioning of the ventilation system must be the following:

- a. Normally the system runs with one ventilator.
- b. The injection system must function only when the ventilation system is active.
- c. If the gas detectors register an explosive atmosphere of 15% of LEL, a second fan is activated, alarm is signalled and the charging system and refrigerant pipeline are automatically shut off.
- d. The system must be manually activated during tests, a small quantity of gas always remains inside the flexible tubes and a small drop is all it takes to create an explosive atmosphere.

Together with this main system an aspiration system for the station should be provided. An example of construction is as follows:

- A number of air intakes distributed along the conveyor belt
- Ventilated container in which the injection gun may be positioned between injections
- An efficient aspiration must be provided in the proximity of the welding station. The welding station is an ignition source always present and must therefore be treated with the greatest caution. The needed measures can only be defined in combination with the used process.
- A low enclosure up to the height of the conveyor can also be installed around the area, without openings of type A, B, C or D with a ventilation system.

This enclosure is classified as virtual zone, sometimes called alarm zone, and the regulations according to ATEX standards classified Zone 2.

6.3 Gas detection system-production line

The gas detection system must be installed following the indications of Chapter 5. In this case due to continuous presence of personnel, two detectors must be installed at each installation point. The gases in use are heavier than air therefore the detectors must be positioned at floor level.

The detectors must be installed underneath the conveyor distributed along the belt in 11 points:

1. In the proximity of the quality test station
2. At the beginning of the vacuum testing station
3. At the end of the vacuum testing station
4. At the charging station
5. At the ultrasonic welding station
6. Inside the leakage control cabin
7. At the assembly line³⁶
8. At the electrical test station
9. At the performance test station
10. At 2nd leakage test after performance test station
11. At the repair station

Figure 23 shows electrical wiring protection to rigid steel pipes. The solution of steel piping has the advantage that the wiring is very well protected and with appropriate marking recognisable. However, it is also possible to use EX suitable electrical wiring but also this wiring needs to be placed in channels and marked.

The assumption is that the equipment has all the required certifications for use with flammable refrigerants. With regard to the charging machine, it will contain one sensor inside the machine.

³⁶ Because the workers move the piping during assembly

Figure 23: Gas sensor in double and single configuration

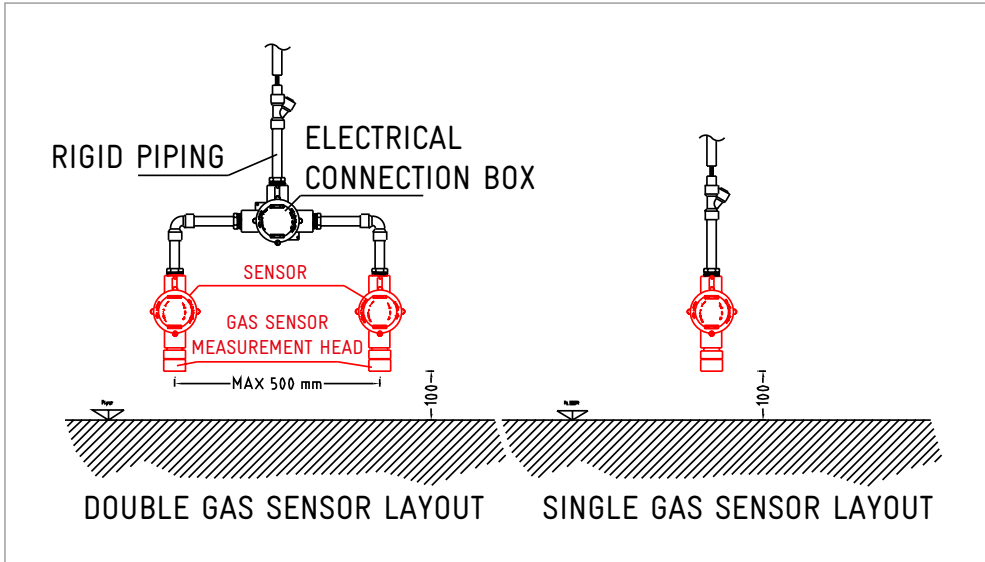

6.4 Refrigerant transfer pump – open air placement

The refrigerant feeding system to the refrigerant charging machine must be constructed as follows:

1. Install a pipeline with nominal pressure of minimum 1.5 times higher than indicated by the refrigerant transfer pump plate.
2. Install a maximum pressure switch which will block the pump if the operational pressure is exceeded.
3. Install a minimum pressure switch connected to sound and visual alarm, signalling a drop of pressure in the circuit. This indicates leakage.
4. Install a safety valve on the tubes (dimensioned adequately) with the discharge located outside the facility in a safe place (non-hazardous) or connected to the ventilation system.
5. Install an automatic ball-valve at the beginning of the station connected to the gas detector system.
6. To increase safety, especially in seismic areas, covering the tubes entering the area would be of great importance. The cover must be connected to the nearest gas detector and ventilation system. Modern refrigerant charging machines have this incorporated into their system to monitor the refrigerant charging pipe. This is achieved by the ventilation system of the charging machine which is connected to the cover of the refrigerant pipe line and the aspirated air is monitored by a gas sensor.

The following equipment makes the department complete:

1. Lighting plant (illumination)
2. Grounding plant preventing electrostatic discharges

Lighting plant:

An appropriate explosion proof emergency lighting system must be provided in this area.

Grounding refrigerant transfer pump area:

The installed equipment and apparatus must be ground connected and a box with antistatic tools should be at hand (e.g. bronze wrenches and hammers) for connecting and disconnecting the refrigerant bottles. Also grounding tools which can be connected to the bottles like grounding cables have to be provided.

The above description is only applicable when:

- **The transfer pump and refrigerant bottles are placed in the open air, protected by a fence with openings allowing a non-obstructed flow of air at an appropriate distance from hazardous areas.**

6.5 Refrigerant transfer pump – closed room placement

In case the refrigerant transfer pump and refrigerant bottles are required to be placed inside a closed room because of ambient conditions (humid, hot areas) or due to the lack of space or large distance to the production area, the required safety measured mentioned under the previous paragraph remain valid and in addition:

- The area is classified EX Zone 2 as bottles are connected and disconnected. PED regulations must be kept in mind.
- **Emission source grade 0:** liquid gas remaining inside the tube and inside the Hansen quick coupler: The quantity is estimated to 0.5 gram per injection³⁷.
- Gas drop expands enormously (*229 times for R600a isobutane*).
- A Zone 0 forms around the injection point.

³⁷ The gas quantity is hypothetical. For each installation the diameter of the tube and the quantity of refrigerant must be verified.

A ventilation system is required according to the requirements of the refrigerant charging area!

6.6 Test stations

The test stations consist of the following components (numbers corresponding to the layout in Figure 21):

- Leakage test station no. 9
- Finishing station no. 10
- Electrical test station no.11
- Performance test station (cabin) no. 12
- 2nd leakage test station no. 13
- System for the emptying of the apparatus to be repaired no. 17

Leakage test station no. 9

The leakage test station is located inside a cabin. The cabin is **Zone 2** area. In normal operation there is no refrigerant leaking. Limited leakage (micro leakage) may occur. The station is however classified as **Zone 2**.

The following systems must be provided:

- No. 1 aspiration plant activated by one ventilator consisting of:
 - a. Aspiration arm diameter 125 mm with capacity of 700 m³/h
 - b. Aspiration nozzle positioned at floor level with capacity of 700 m³/h

The system must be constructed by the criteria's defined in the previous paragraphs. Further the plant must be manually controlled by operator. Under normal conditions the aspiration system is in low conditions. In case of detected leakage the operator must proceed to:

1. Activation of the ventilator in high mode
2. Emptying the gas compressor of refrigerant using the emptying equipment
3. Discharging the gas evacuated from the compressor into the aspiration system

Finishing station no. 10

Normally, no Emission Sources (ES) present, but due to the work the tube can break. Therefore some leakage can occur. This must be detected and signalled by the gas detection system and the electricity must cut off automatically. The equipment used is intended for Zone 2.

Electrical test no. 11

Normally there are no emission sources, but as high tension for these tests is applied, a gas sensor in combination with a ventilation system as described before is required. Use of equipment is intended for Zone 2.

Performance test cabin no. 12

The performance test cabin may consist of one or more test stations. In this area, even if it is of reduced dimensions, there may be the same problems as with the injection station. The apparatus must be connected by tubes to the test splits to simulate the correct conditions of functioning.

The area contains continuous ES, therefore detachment of the nozzle and flexible tube from the tested apparatus means in fact leakage of several grams of refrigerant. This quantity means **Zone 0** as described before. Therefore the same ventilation measures have to be taken per connection point as described above.

In addition there is a room ventilation system. To reduce the aspired air quantity and also the energy heating/cooling the air, it is necessary to install a second ventilation plant with the same features as the first, but more efficient. With a volumetric flow rate of minimum 4000 m³/h and suction power of approx. 100 mm H₂O. The second plant will be connected to the detection system and will not be functioning during normal operation. Activation will start when 15% LEL is reached.

The area is Zone 2 in the proximity of the tested apparatus.

Performance test cabin – gas detection

The gas detection system must be installed following the indications. In this case due to continuous presence of personnel it is important to install two gas detectors. The gases in use are heavier than air therefore the detectors must be installed at floor level.

The gas detectors must be installed in the following points:

- two in proximity of tested apparatus
- two in proximity of each entrance door (dependant on the size of the room and detectors measurement range)

Second leakage control station no. 13

Normally no ES or classified hazardous areas are present. However in case of leakage the flammable emission must be discharged. Therefore a ventilation system is required similar to the first leakage station. It has to be connected to the performance test room evacuation system. The additional needed evacuation capacity has to be considered.

As precaution it should be classified as Zone 2 and also include a gas sensor in this location.

Transport of malfunctioning unit from any area of the production line

There are several places where the equipment is tested. All these tests have the purpose of verifying the proper functioning of the unit. In case of malfunctioning in e.g. the first leakage test area, it would be needed to cover a long distance before arriving to the repair area.

The transport could also go beyond the production line boundary in areas where the personnel are not informed and/or trained for using flammable refrigerants.

The reason of the malfunctioning is not always evident and on a production line there is seldom time to verify this in detail.

Therefore it is mandatory to forward the malfunctioning unit to proper handling/ repair/destruction/ disassembly. For this reason the proper procedure is to:

- Use an EX vacuum pump connected to the ventilation duct and discharge the complete content of refrigeration inside the unit. The amount of refrigerant inside the unit influences the dimensioning and zoning of the evacuation system. These pumps are also combined with a pre-evacuation through a venturi type pre-evacuation.
- Achieve a high level of vacuum inside the unit. With the EX vacuum pump a low level of vacuum is achieved which however will depend on the actual leakage size.
- Transport the depleted unit to a repair area inside the production boundary.
- Flush the unit with nitrogen before trained personnel will proceed for repair.

This procedure will be done in the repair area. For transportation, the equipment used should be suitable for Zone 2.

Repair area no. 15

Before repairing, a damaged apparatus must be emptied of refrigerant. The refrigerant evacuated from the apparatus must be discharged into the ventilation system.

The repair area is equipped with:

- Ventilation system
- Gas sensors

and is classified as Zone 2 NE.

7 SUMMARY IDENTIFICATION OF HAZARDOUS AREAS

7.1 Introduction

The determination process of hazardous areas is the classification of areas according to the ATEX directives and associated standards. The classification must always be performed by an expert in the field.

The purpose of this document is to explain the process to the commissioning company and the person in charge of the installations.

The illustrated examples are merely suggestions and *not* examples of an executive project.

7.2 Quick guide to refrigerant analysis

The base for risk evaluation is the identification of the substances used in the production process.

First questions to be asked are:

- a. How many substances are used in our production?
- b. How many are flammable among these substances?
- c. How do I know if a substance is flammable?

The answer to the first question is given by the type of technological production cycle. The answers to questions b and c can be found in the **MSDS** of each product in use.

All products commercialised within the European Union must be accompanied by an **MSDS**.

The **MSDS** must contain minimum 16 paragraphs:

1. Identification of the substance and the name of the selling company
2. Chemical composition
3. Identification of the hazards
4. First Aid instructions
5. Fire fighting measures

6. Instructions in case of accidental dispersion
7. Handling and storage
8. Personal protection
9. Chemical and physical characteristics
10. Stability and reactivity
11. Toxicological information
12. Ecological information
13. Disposal
14. Transportation
15. Standards and regulation information
16. Other information

In particular, the information regarding the refrigerant analysis is included in the sections: **3, 5, 9 and 15**.

With regards to the determination process:

- The substance must be identified as flammable or not: **point no. 3**
- If it is flammable then it is necessary to make the identification of the fire fighting measures: **point no. 5**
- The characteristics must be identified in order to begin the classification of zoned areas
- Zoned areas under ATEX: **point no. 9**. The characteristics are:

- 1. Physical state at 20°C:** serves to establish if it is a liquefied gas or a liquid
- 2. Auto-ignition temperature:** serves to establish the temperature class of the equipment
- 3. Flammable limits:** only inferior limit is important. Serves to calibrate the gas detectors
- 4. Gas or liquid density:** serve for the positioning of aspiration nozzles and gas detectors

Move to **point 1** to determine and to identify the values indicated in Chapter 1.1:

1. Labelling of hazardous substances, e.g.: **F+ = extremely flammable**
2. Nature of specific risks, e.g.: **R11 = Easily flammable**

7.3 Quick guide to the identification of hazardous areas

To quickly identify hazardous areas, it is important to find out where the substances are used. Generally, they can be found in the following areas of the facility:

- Storage
- Pumping room
- Piping
- Ventilation ducts
- Injection department
- Control and test department
- Storage of finished product
- Repair areas

Subsequently the following must be identified:

- a. Substance is stored in container from which it can get in contact with the surrounding environment due to malfunction or damage. The areas are:
 - Tank storage and fixed tank
 - Piping
 - Ventilation ducts

These areas are classified as **Zone 2**.

It must be checked that these areas (Zone 2) are in contact with other areas. If they are, then the type of “**opening**” connecting the areas must also be classified.

- b. Areas where the substances are in contact with the surrounding atmosphere, e.g. an injection station. *Without ventilation system this area would be classified Zone 0 or Zone 1.*
- c. Check that ventilation system does actually function the way predicted. It should reduce the hazardous area to a point of a few cm³. If yes then the area can be classified **Zone 0 NE**.

The facility should as often as possible aim to be equipped with:

- **Zone 2 NE**
- **Zone 0 NE**

Whereby, with appropriate ventilation and gas sensors NE classification for both zones can be achieved.

7.4 Quick guide to the identification of a substance

It is necessary to find out if the machinery/equipment/system already installed or to be installed are adequate to the plant.

This is done with the following procedure:

- If using a flammable substance then hazardous area standards must be applied.

Ex-rated equipment must be applied to Zone 0, 1 and 2.

All machinery/equipment/system installed in these zones must have:

- Plate/label with the EX symbol inside a hexagon
- Certification

Choice of equipment: In general it is recommended to use equipment designed for Zone 2 areas as a minimum.

APPENDICES

Appendix 1: Typical refrigerants used

- R600a
- R1270
- R1234yf
- R290
- R161
- R32

Please refer to the supplier's safety data sheet of the refrigerant in use for the safety assessment!

Appendix 2: Influence of ventilation on type of Zone

Extract of Table B1 EN 60079-10 2009

GRADE OF RELEASE	VENTILATION						
	DEGREE						
	HIGH		MEDIUM			LOW	
	AVAILABILITY						
	GOOD	FAIR	POOR	GOOD	FAIR	POOR	POOR GOOD FAIR OR POOR
CONTINUOUS	ZONE 0 NE	ZONE 0 NE	ZONE 0 NE	ZONE 0	ZONE 0 + ZONE 2	ZONE 0 + ZONE 1	ZONE 0
	NON-HAZ- ARDOUS ¹	ZONE 2 ¹	ZONE 1 ¹				
PRIMARY	ZONE 1 NE	ZONE 1 NE	ZONE 1 NE	ZONE 1	ZONE 1 + ZONE 2	ZONE 1 + ZONE 2	ZONE 1 or ZONE 0 ²
	NON-HAZ- ARDOUS ¹	ZONE 2 ¹	ZONE 2 ¹				
SECONDARY	ZONE 2 NE	ZONE 2 NE	ZONE 2	ZONE 2	ZONE 2	ZONE 2	ZONE 1 and even ZONE 0 ²
	NON-HAZ- ARDOUS ¹	NON-HAZ- ARDOUS ¹					

Note: "+" signifies "surrounded by".

- 1 zone 0 NE, 1 NE or 2 NE indicates a theoretical zone which would be of negligible extent under normal conditions.
- 2 will be zone 0 if the ventilation is so weak and the release is such that in practice an explosive atmosphere exists virtually continuously (i.e. approaching a "no ventilation" condition).

Appendix 3: List of standards / references

Standards:

- EG Directive 99/92/CE generally called “ATEX directives”
- EG Directive 94/9/CE
- EN 1127-1 Explosion protection, fundamentals and methods
- Directive 97/23/CE PED European Pressure Vessel Directive
- Electrotechnical regulations: International: IEC/ European: EN / National: DIN VDE e.g. IEC 60073, IEC 439-1/A2, IEC 204-1, IEC 1210-2, EN 60079-29-1, EN 50013, EN 60079-11, EN 61000-6-3, EN 60529
- EN 378, refrigerating systems and heat pumps, safety and environmental requirements
- EG machine Directive
- IEC 60079-10/EN 60079-10/VDE 0168 part 101: Electrical apparatus for explosive gas atmospheres – classification of hazardous areas / Italian: CEI 31-35 Guide for classification of hazardous areas
- IEC/EN/DIN VDE standards: especially DIN 31000/ VDE 1000, DIN VDE 0116
- EN 60079 – Explosive atmospheres
- EN 61508 – Functional safety
- EN 61511 – Functional safety- safety instrumented systems for the process industry sector
- EN 13463 – Non electrical equipment for potentially explosive atmospheres

References for further reading:

- GTZ Proklima (2010): Guidelines for the safe use of hydrocarbon refrigerants – a handbook for engineers, technicians, trainers and policy-makers – for climate friendly cooling.
- GTZ Proklima (2009): Natural Foam Blowing agents – sustainable Ozone- and Climate- Friendly Alternatives to HCFC’s.
- GTZ Proklima (2008): Natural Refrigerants - sustainable Ozone- and Climate-Friendly Alternatives to HCFC’s.

Deutsche Gesellschaft für
Internationale Zusammenarbeit (GIZ) GmbH

Registered Offices
Bonn and Eschborn

Programme Proklima

Dag-Hammarskjöld-Weg 1-5
65760 Eschborn/Germany
T +49 61 96 79-1022
F +49 61 96 79-80 1022
E proklima@giz.de
I www.giz.de/proklima